

Please go to www.quoizel.com for product cleaning tips. Go to the **Care + Maintenance** selection.

Tools Required: Flathead screwdriver, Phillips screwdriver, pliers, wire cutters, wire strippers, electrical tape, safety glasses.

Light Source: (3) Medium Base Bulbs 100W Maximum, bulb not included.

Estimated Assembly Time: 30-45 minutes

Preparation: Identify and inspect all parts before beginning installation. Check package content list and diagrams below to be sure all parts are present. If any parts are missing or damaged, do not attempt to assemble, install, or operate the fixture. Missing Parts? Contact your original place of purchase.

⚠ Warnings and Cautions

Turn off electricity at circuit breaker or main fuse box before installation. Consult a licensed electrician if in doubt.

These instructions are provided for your safety. It is very important you read them completely before installing the fixture. We strongly recommend that a licensed, professional electrician perform the installation.

Disconnect fixture from power source before replacing bulbs. Make sure bulbs are given sufficient time to cool before removal.

Package Contents

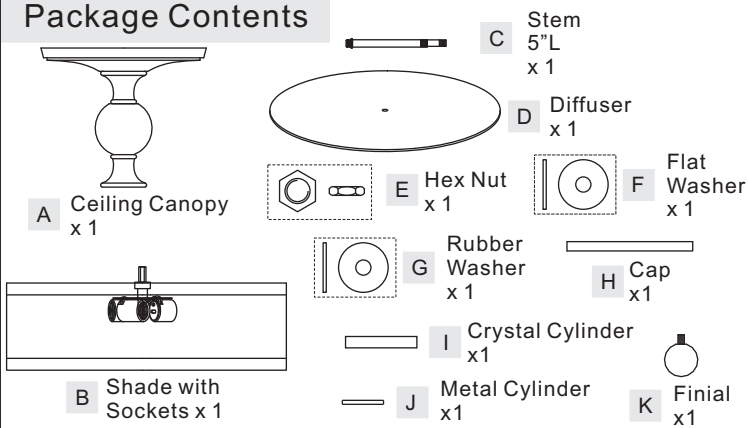

Hardware Contents

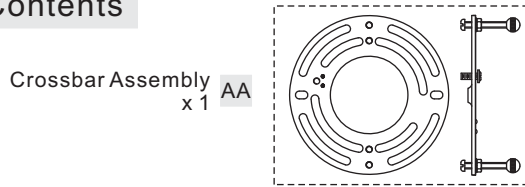

STEP 1 - Assemble Shade with Sockets and Ceiling Canopy

- A. Thread the Ceiling Canopy (A) onto the nipple on the top center of the Shade with Sockets (B) and tighten until snug.

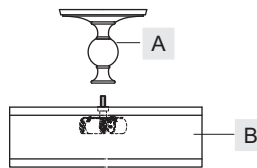

STEP 2 - Install Diffuser

- A. Thread the beaded end of the Stem (C) into the Coupling on the bottom center of the Shade with Sockets (B). Hand tighten until snug.
B. Locate the Diffuser (D), the Rubber Washer (G) and the Flat Washer (F) over the end of the Stem (C) and secure with the Hex Nut (E). Hand tighten until snug.

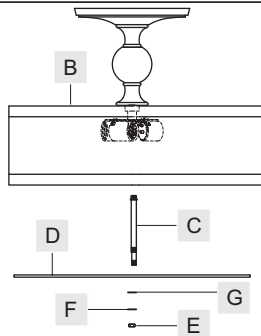

STEP 3 - Install Cylinders

- A. Pass the Cap (H), the Crystal Cylinder (I) and the Metal Cylinder (J) over the end of the Stem (C). Secure them by threading the Finial (K) with Nipple into the Stem (C). Hand tighten until snug.

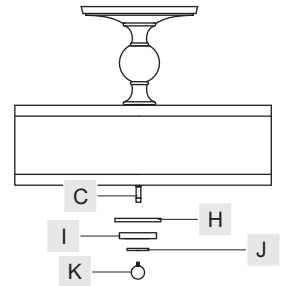

STEP 4 - Install Crossbar Assembly

- A. Pass the supply wires through the Crossbar Assembly (AA). Attach the Crossbar Assembly (AA) to the Outlet Box with the head of the Green Ground Screw facing you. Secure it with Outlet Box Screws (not included). Tighten until snug.

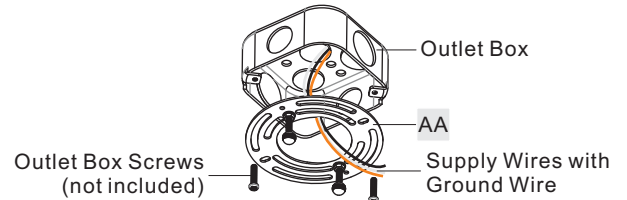

STEP 5 - Test Fit the Ceiling Canopy to the Crossbar Assembly

- A. Remove the mounting balls from the Crossbar Assembly (AA). Place the Ceiling Canopy (A) onto the Crossbar Assembly (AA) and secure with mounting balls. Note: The Ceiling Canopy (A) should be snug against the ceiling and held tight with the mounting balls. If it is not, adjust the length of the mounting screws on the Crossbar Assembly (AA) by unscrewing the preassembled hex nut and lock washer and then screwing the mounting screws in or out of the crossbar until the correct length is achieved. Once the Ceiling Canopy (A) is secure, remove the mounting ball and Ceiling Canopy (A) and proceed to Step 6.

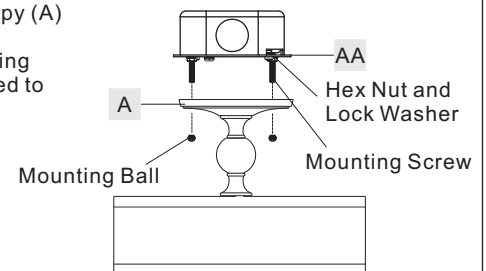

STEP 6 - Wire Connections

- A. Wrap bare or green ground wire around green ground screw on the crossbar, no less than 2 inches from the end of the wire. Tighten the green ground screw.
- B. Use standard wire connectors (not included) to make all wire connections. Twist connectors until wires are tightly joined together. Wrap each connection with approved electrical tape and carefully stuff all the connected wires into the Outlet Box.

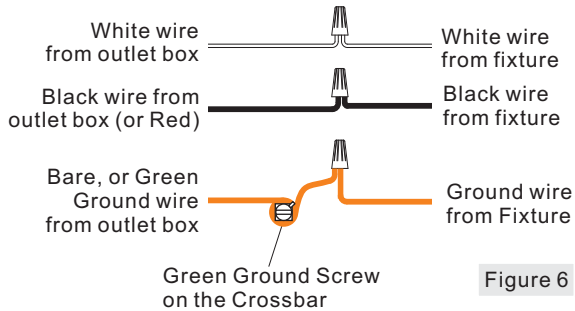

STEP 7 - Install the Fixture Body

- A. Position the Ceiling Canopy (A) onto the Crossbar Assembly (AA). Place the holes in the Ceiling Canopy (A) over the mounting screws. Secure the Ceiling Canopy (A) by using the mounting balls and hand tighten the mounting balls until snug.

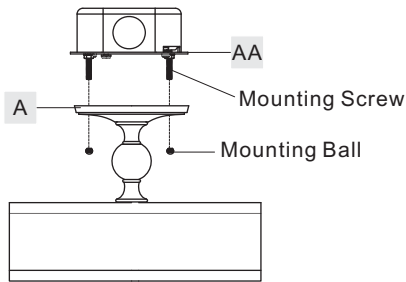

STEP 8 - Install Bulbs

- A. Insert bulbs onto sockets and screw snugly into place.
- Your fixture is now assembled and ready to use. Enjoy!

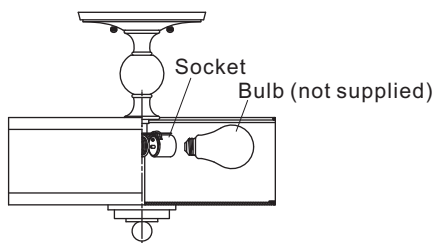

DW1717C

FINISH: POLISHED CHROME

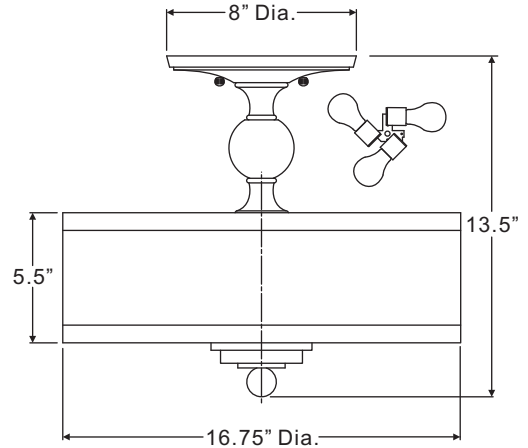
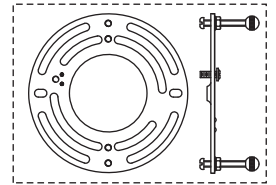

NOTE: ALL DIMENSIONS ARE ROUNDED UP TO THE NEAREST 1/4"