

SAFETY INFORMATION

Please read and understand this entire manual before attempting to assemble, install or operate the product.

WARNING

- RISK OF ELECTRIC SHOCK - Before beginning installation, turn off electricity at the circuit breaker box or the main fuse box.
- RISK OF FIRE - Use bulbs specified by the markings and/or labels on the fixture.

CAUTION

- For your safety, read instructions completely before beginning installation.
- If in doubt about electrical installation, consult a licensed electrician.
- Turn off electricity to fixture before replacing the bulb(s).

TOOLS REQUIRED

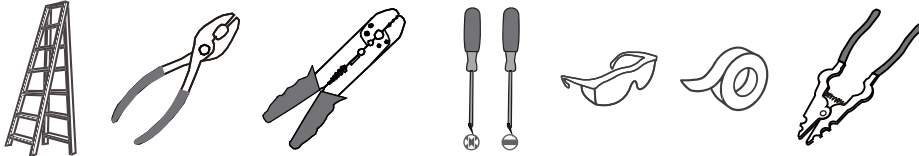

CARE AND MAINTENANCE

- Wipe clean using soft, dry cloth or static duster. Always avoid using harsh chemicals and abrasives to clean fixture as they may damage the finish.

If you need further assistance call Quoizel Customer Care at 1-800-645-3184 (9:00am - 5:00pm EST), or visit us on-line at www.quoizel.com.

PACKAGE CONTENTS

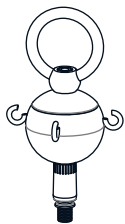

A Fixture Loop Assembly
x 1



C Center Rod
x 1



D Side Chain
x 4

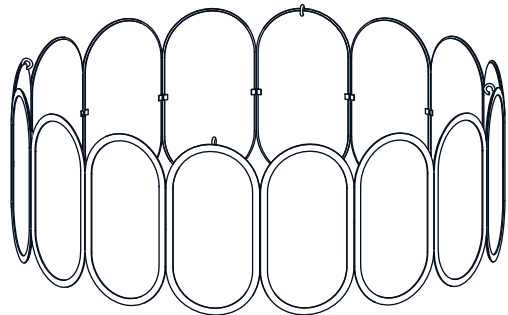

E Shade
x 4

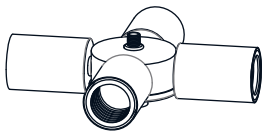

B Socket Assembly
x 1

MOUNTING HARDWARE

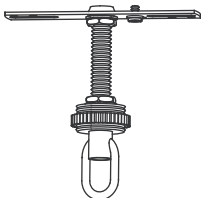

AA Crossbar Assembly
x 1



BB Wire Connector
x 3



CC Outlet Box Screw
x 2

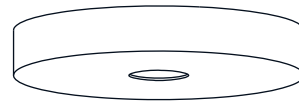

DD Ceiling Canopy
x 1



EE Quick Link
x 2



FF Fixture Chain
x 1

1 Thread Fixture Loop Assembly, Center Rod and Socket Assembly together

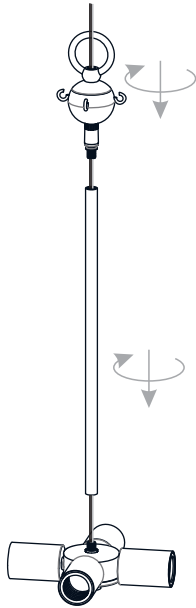

2 Install Crossbar Assembly

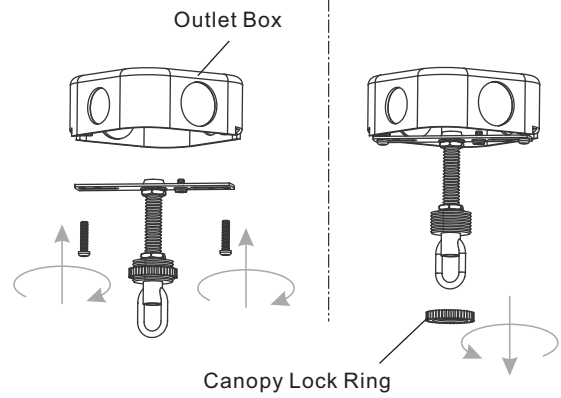

3 Install Fixture Chain

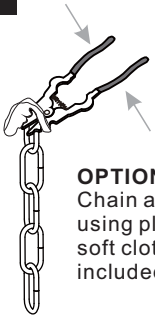

OPTIONAL: Adjust Chain as desired, using pliers and soft cloth (neither included).

Suggested chain length for Ceiling height:
 8 feet ceiling: use 8 links of chain and 2 quick links
 9 feet ceiling: use 18 links of chain and 2 quick links
 10 feet ceiling: use 28 links of chain and 2 quick links.

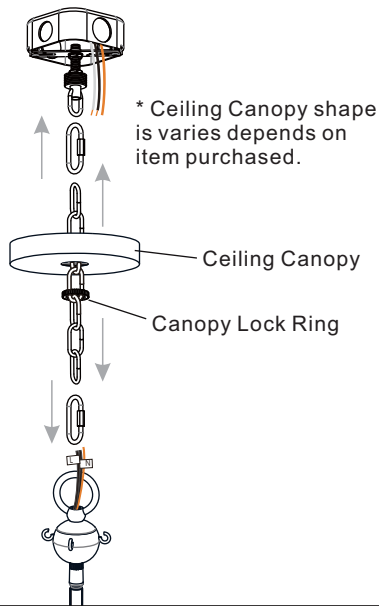

4 Pull Supply Wires

Pull the supply wires with ground wire through the chain alternate links.

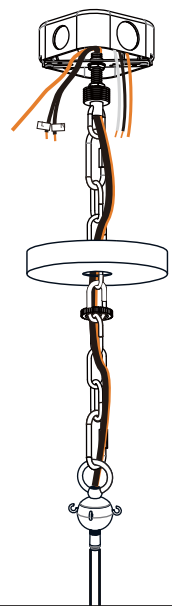

5 Wiring

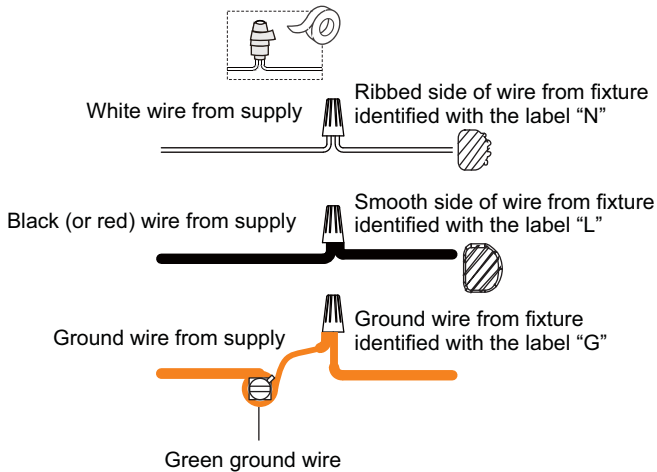

6 Install Ceiling Canopy

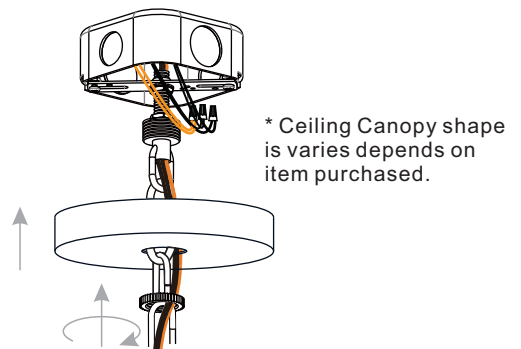

7 Install Shade with Side Chains

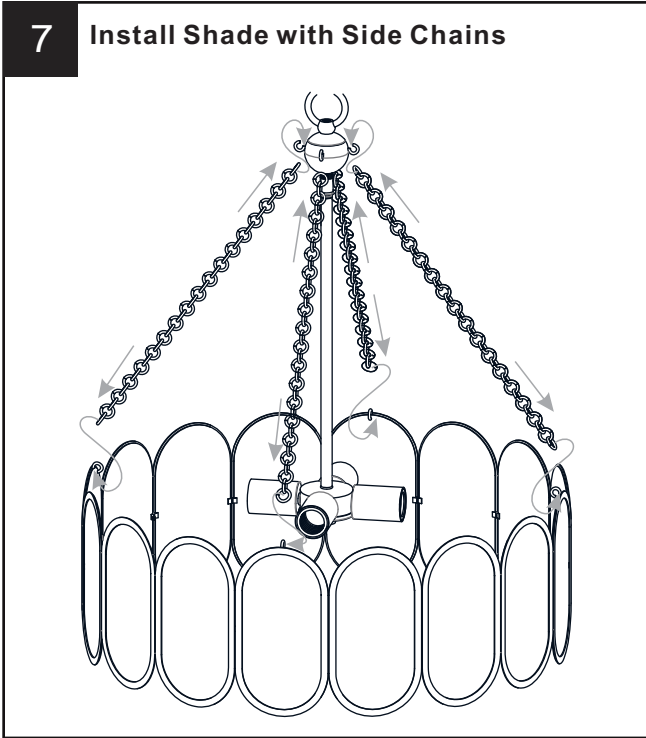

8 Install Bulbs

Install four correct bulbs referring to fixture markings and/or labels for maximum wattage.

Recommended Bulb Type (not included):

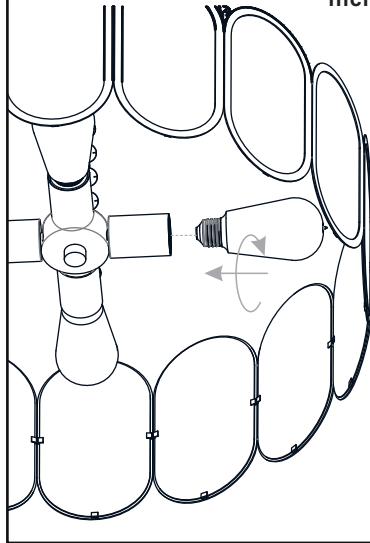

BULB BASE TYPE
Medium (E26)

BULB TYPE
TYPE A

Your installation is now complete! Restore electricity and save this sheet for future reference.