

Assembly Instruction Sheet #IS-RBN1622

For Styles RBN1622C, RBN1622SG, RBN1622MN, RBN1622W and RBN1622WT

Please go to www. quozel. com for product cleaning tips. Go to the **Care + Maintenance** selection.

Tools Required: Flathead screwdriver, Phillips screwdriver, pliers, wire cutters, wire strippers, electrical tape, safety glasses.

Light Source: (5) G9 Xenon Frosted bulb (Supplied), 40W Maximum.

Estimated Assembly Time: 20-30 minutes

Preparation: Identify and inspect all parts before beginning installation. Check package content list and diagrams below to be sure all parts are present. If any parts are missing or damaged, do not attempt to assemble, install, or operate the fixture. Contact customer service for replacement parts.

⚠ Warnings and Cautions

Turn off electricity at circuit breaker or main fuse box before installation. Consult a licensed electrician if in doubt.

These instructions are provided for your safety. It is very important you read them completely before installing the fixture. We strongly recommend that a licensed, professional electrician perform the installation.

Disconnect fixture from power source before replacing bulbs. Make sure bulbs are given sufficient time to cool before removal. Do not subject glass parts to any shock while in operation or shattering may result.

Do not touch the bulb with bare hands use a cloth or glove.

Package Contents

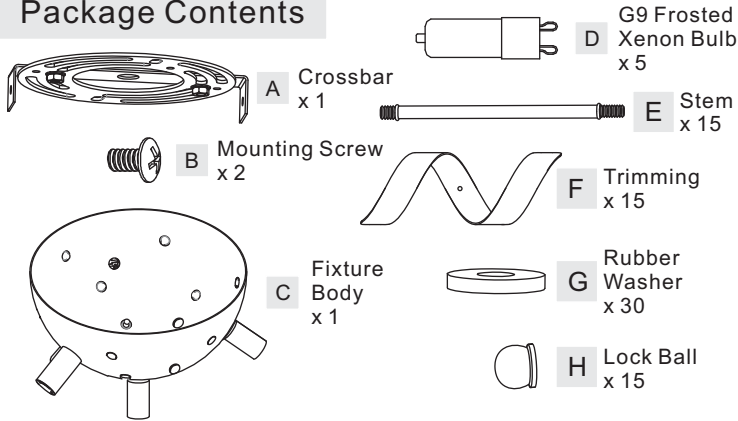

STEP 1 - Attach Crossbar to Outlet Box

A. Attach the Crossbar (A) to Outlet Box and secure by threading Outlet Box Screws (not supplied) into the Mounting Holes on the Outlet Box. Tighten until snug.

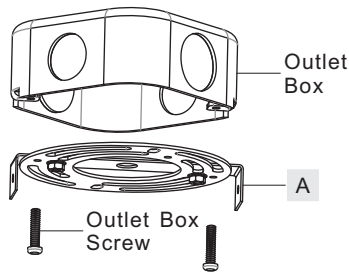

Figure 1

STEP 2 - Wire Connections

A. Use standard wire connectors (not included) to make all wire connections. (Connectors are not included with fixture.) Twist connectors until wires are tightly joined together. Wrap each connection with approved electrical tape and carefully stuff all the connected wires into the Outlet Box.

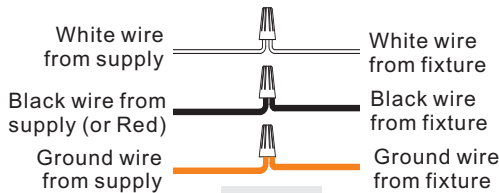

Figure 2

STEP 3 - Attach Ceiling Canopy to Crossbar

A. Line up the Hole on the Fixture Body (C) and the Mounting Hole on the Crossbar (A), secure by thread the Mounting Screw (B) into the Mounting Hole. Tighten until snug.

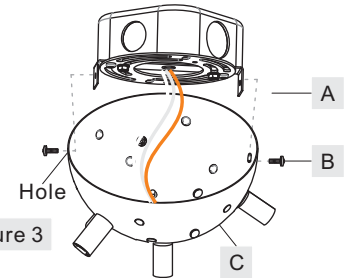

Figure 3

STEP 4 - Install Bulbs

A. This fixture uses frosted G9 Xenon bulb (D) with G9 base. Maximum 40 watts. Insert bulb and push snugly into place.

IMPORTANT: Do not touch the bulb with bare hands use a cloth or glove.

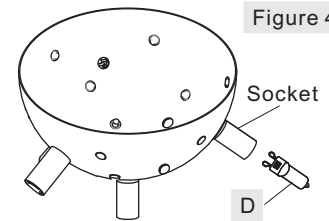

Figure 4

STEP 5 - Install Trimming to Fixture

A. Thread the Short Nipple end of Stem (E) into the Fixture Body (C), hand tighten until snug.
 B. (For item RBN1622C) Peel off Protective Films on Trimmings (F). Note: Gloves are required to avoid leaving fingerprints or scratches on Trimmings (F).
 C. Place the Trimming (F) and Rubber Washer (G) over the other end of Stem (E). Secure by threading Lock Ball (H) onto the Stem (E). Hand tighten until snug.

Your fixture is now assembled and ready to use. Enjoy!

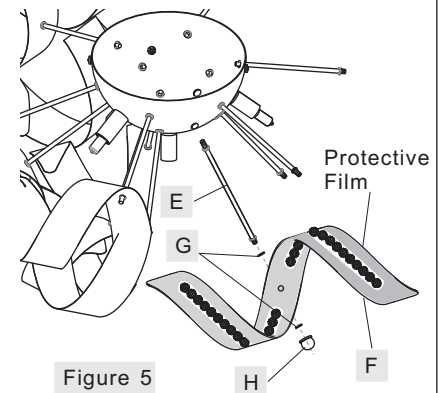

Figure 5

Thank you for purchasing a Quoizel product.
Need assistance with parts or assembly? Call Quoizel customer service at 1-631-273-2700
or visit us on-line at www. quozel. com

CAUTION FOR BULB REPLACING

- A. When replace bulb, turn off power and allow lamp to cool. For safety purpose, wear gloves and eye protection.
- B. If bulb is scratched or cracked, DO NOT use the lamp to avoid breakage during use or installation.
- C. Use only in fixtures rated for lamps wattage and voltage.
- D. Prevent the bulb from contacting liquid or combustible materials.

RBN1622C/RBN1622SG/RBN1622MN
/RBN1622W/RBN1622WT

FINISH: POLISHED CHROME/SATIN COPPER
/MILLENNIA/WHITE LUSTRE
/WESTERN BRONZE

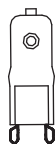
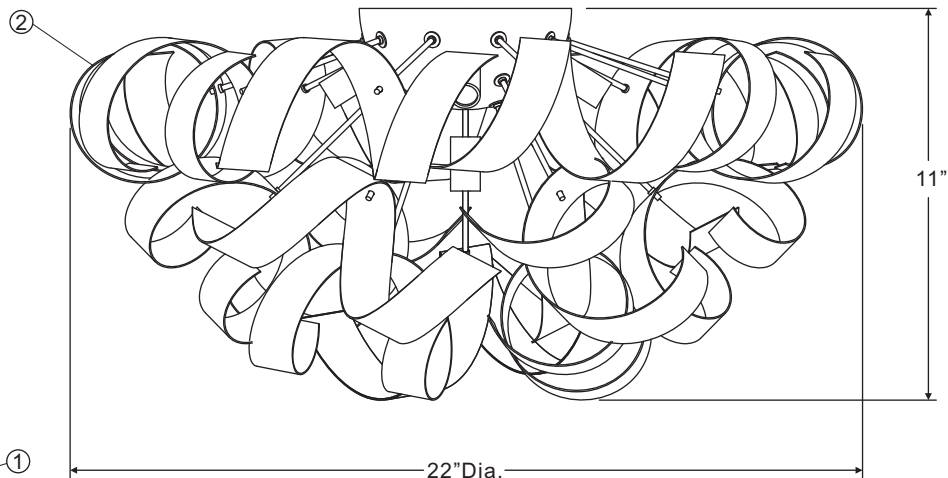
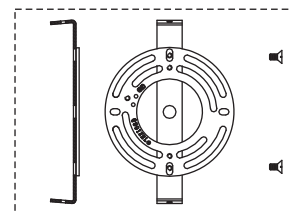

(5) 40W Maximum
G9 Xenon Frosted
Bulbs (Supplied)

NOTE: ALL DIMENSIONS ARE ROUNDED UP TO THE NEAREST 1/4"

NO.	PART NUMBER	REPLACEMENT PART DESCRIPTION	REQ.	STYLE NUMBER
1	I1203SF	XENON G9 FROSTED BULB	5	RBN1622C/RBN1622SG /RBN1622MN/RBN1622W /RBN1622WT
2	S12013C	SHADE RIBBON POLISHED CHROME	15	RBN1622C
2	S12016SG	SHADE RIBBON SATIN COPPER	15	RBN1622SG
2	S12015MN	SHADE RIBBON MILLENNIA	15	RBN1622MN
2	S12017W	SHADE RIBBON WHITE LUSTRE	15	RBN1622W
2	S12018WT	SHADE RIBBON WESTERN BRONZE	15	RBN1622WT

Thank you for purchasing a Quoizel product.
Need assistance with parts or assembly? Call Quoizel customer service at 1-631-273-2700
or visit us on-line at www.quoise.com