

SAFETY INFORMATION

Please read and understand this entire manual before attempting to assemble, install or operate the product.

WARNING

- RISK OF ELECTRIC SHOCK - Before beginning installation, turn off electricity at the circuit breaker box or the main fuse box.
- RISK OF FIRE - Use bulbs specified by the markings and/or labels on the fixture.

CAUTION

- For your safety, read instructions completely before beginning installation.
- If in doubt about electrical installation, consult a licensed electrician.
- Turn off electricity to fixture before replacing the bulb(s).

TOOLS REQUIRED

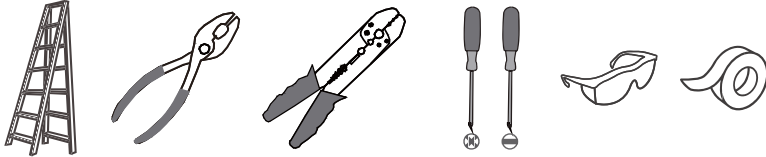

CARE AND MAINTENANCE

- Wipe clean using soft, dry cloth or static duster. Always avoid using harsh chemicals and abrasives to clean fixture as they may damage the finish.

If you need further assistance call Quozel Customer Care at 1-800-645-3184 (9:00am - 5:00pm EST), or visit us on-line at www.quozel.com.

PACKAGE CONTENTS

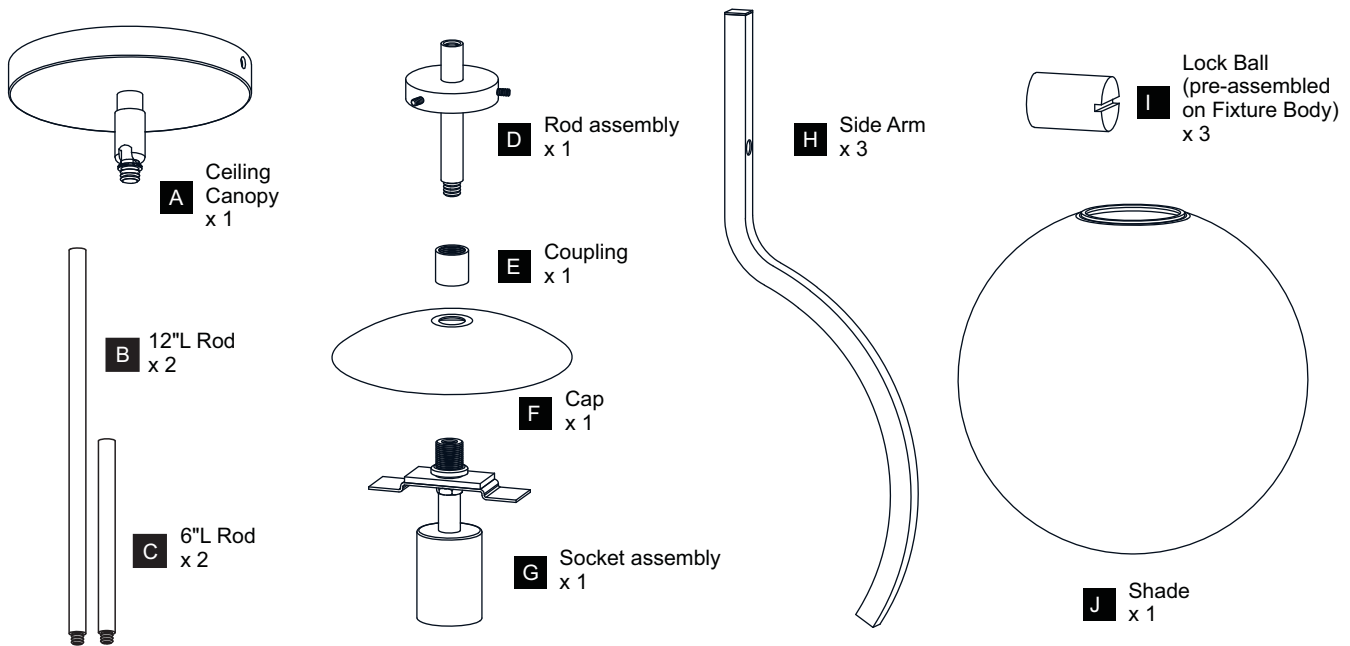

MOUNTING HARDWARE

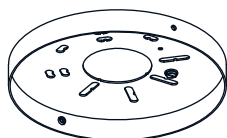

AA Inner Blackplate x 1



BB Wire Connector x 3



CC Outlet Box Screw x 2



DD Lock Screw x 3

INSTALLATION

Quoizel recommended two people for this installation.

1 Install Rod Assembly and Socket Assembly together

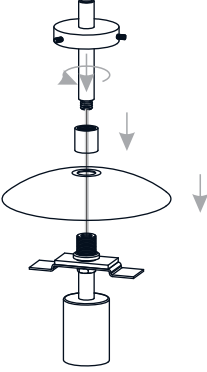

2 Install Rods

Optional Rods:
8 Feet Ceiling:
(2) 12"L Rods.
9 Feet Ceiling:
(2) 6"L Rods + (2) 12"L Rods.

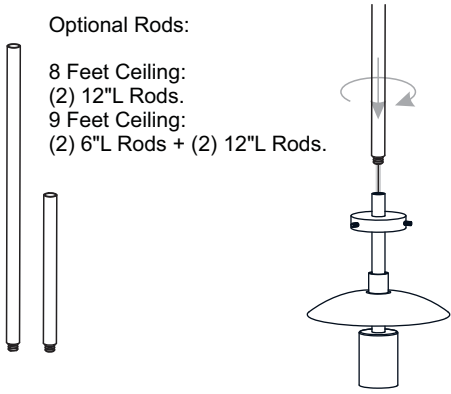

3 Install Ceiling Canopy to Upper Rod

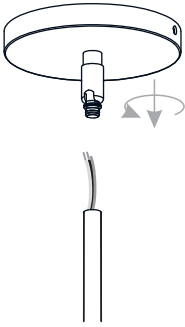

4 Install Crossbar Assembly

Outlet Box

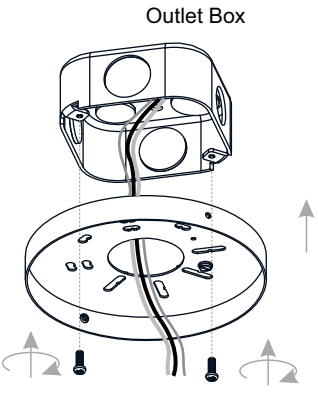

5 Wiring

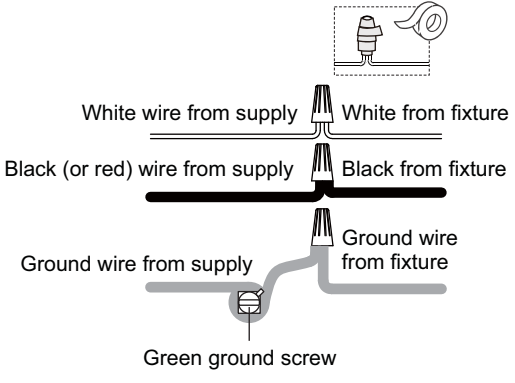

White wire from supply White from fixture
Black (or red) wire from supply Black from fixture
Ground wire from supply Ground wire from fixture
Green ground screw

6 Install Ceiling Canopy to Inner Backplate

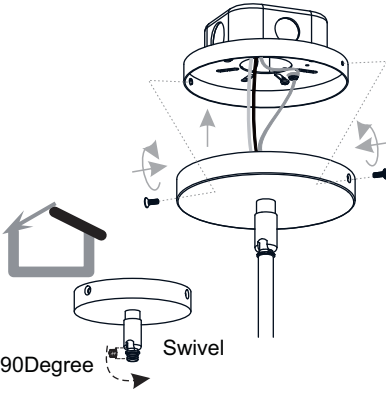



90Degree Swivel
For angled ceilings, Swivel opening towards wall.

7 Install Bulb

Install the correct bulb referring to fixture markings and/or labels for maximum wattage.

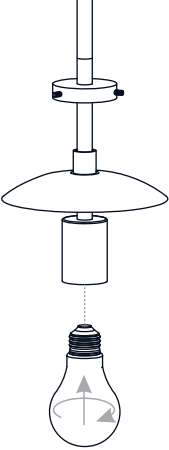
Recommended Bulb Type (not included):



 BULB BASE TYPE Medium (E26)  BULB TYPE TYPE A

8 Install Shade

Quoizel recommended two people for this installation.

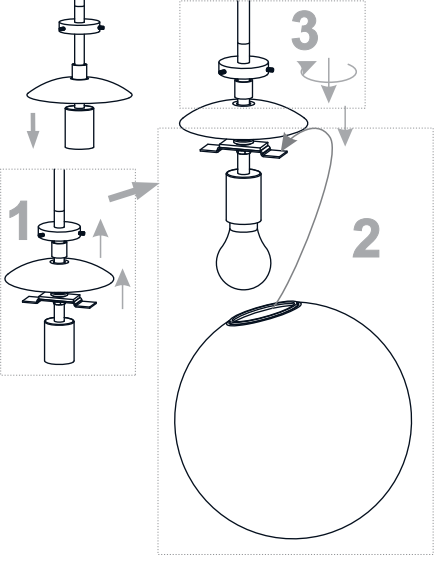

9 Install Side Arm

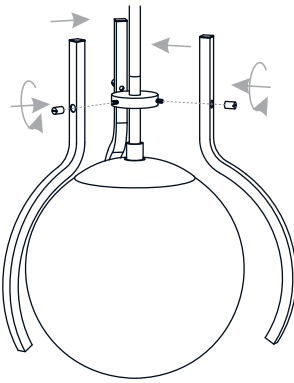

Your installation is now complete! Restore electricity and save this sheet for future reference.