

**Tools Required**

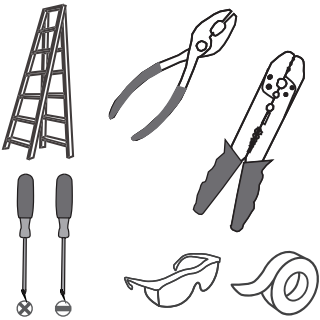

**Light Source**

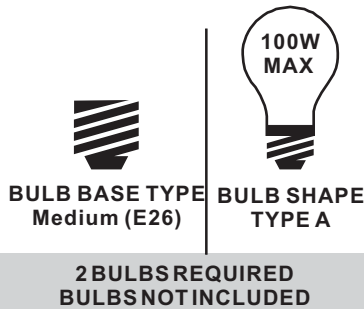

**Warnings and Cautions**

Turn off the electricity at the circuit breaker before installation. Consult a licensed electrician if in doubt about installation.

Turn off power to the fixture and allow the bulbs to cool before replacing.

**Package Contents**

**Preparation:** Identify and inspect all parts before beginning the installation.

Missing or damaged parts? Contact your original place of purchase.

**PARTS BAG**

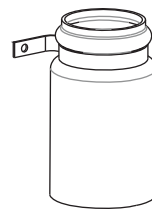
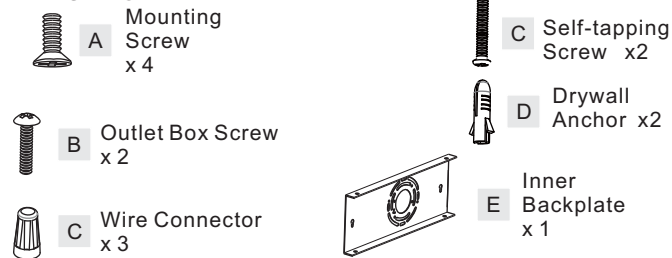

Shade  
F x 2

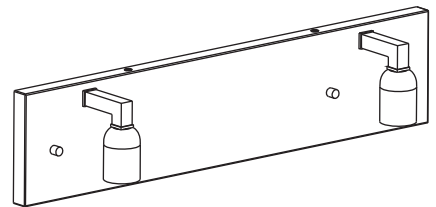

Fixture Body  
G x 1

**Table of Contents**

Inner Backplate	Wiring	Fixture Body	Shade & Bulb
STEP 1	STEP 2	STEP 3	STEP 4

**STEP 1**

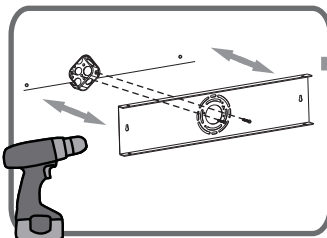

Using a pencil (not included), mark the locations on the wall that correspond with the holes on inner backplate. Using a 5/16-inch drill bit (not included), drill pilot holes at marked locations.

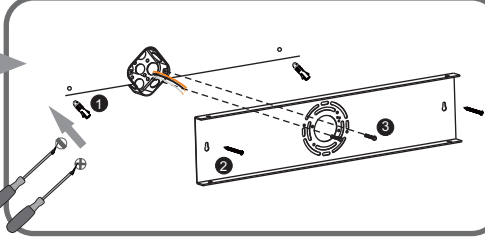

For drywall installations, insert wall anchors into the holes. Otherwise, secure crossbar assembly using self-tapping screws. Then, fully tighten the outlet box screws.  
**CAUTION:** Do not overtighten the screws as damage to the bracket could occur.

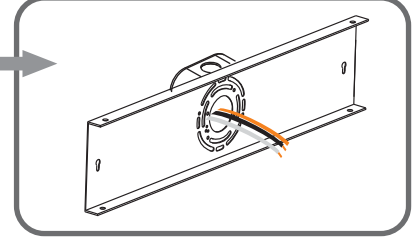

## STEP 2

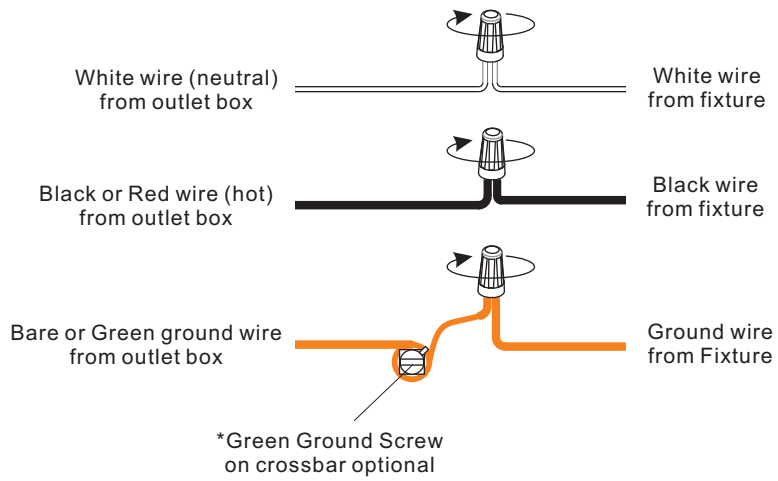

## STEP 3

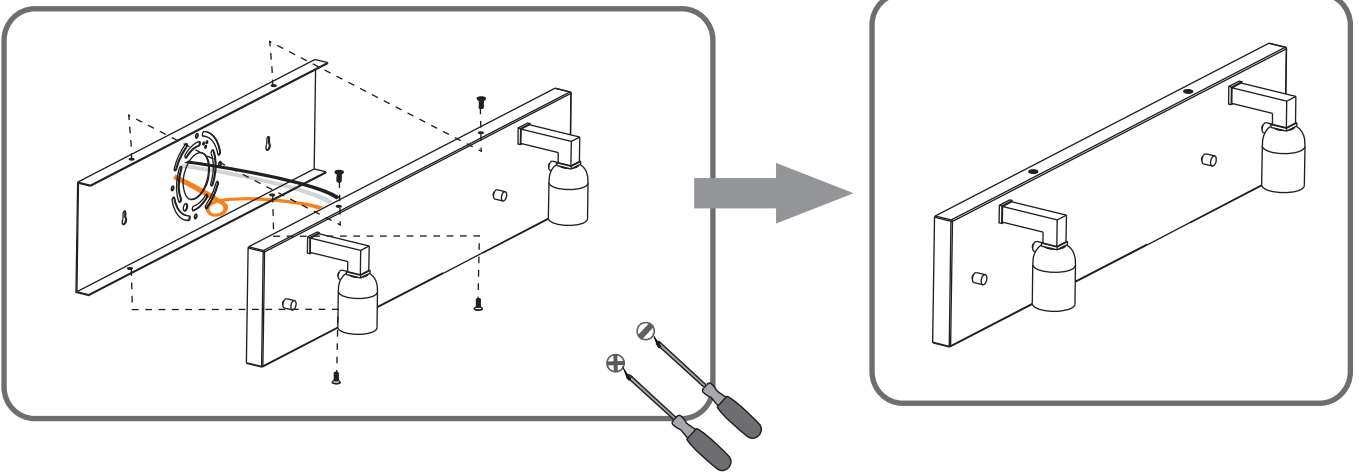

## STEP 4

