

**! SAFETY INFORMATION**

Released Date: 2022-07-20

Please read and understand this entire manual before attempting to assemble, install or operate the product.

**WARNING**

- RISK OF ELECTRIC SHOCK - Before beginning installation, turn off electricity at the circuit breaker box or the main fuse box.
- RISK OF FIRE - Use bulbs specified by the markings and/or labels on the fixture.

**CAUTION**

- For your safety, read instructions completely before beginning installation.
- If in doubt about electrical installation, consult a licensed electrician.
- Turn off electricity to fixture before replacing the bulb(s).

**TOOLS REQUIRED**

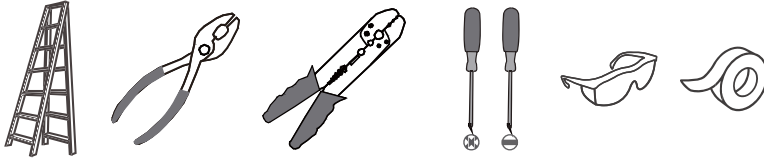

**CARE AND MAINTENANCE**

- Wipe clean using soft, dry cloth or static duster. Always avoid using harsh chemicals and abrasives to clean fixture as they may damage the finish.

If you need further assistance call Quozel Customer Care at 1-800-645-3184 (9:00am - 5:00pm EST), or visit us on-line at [www.quezel.com](http://www.quezel.com).

**PACKAGE CONTENTS**

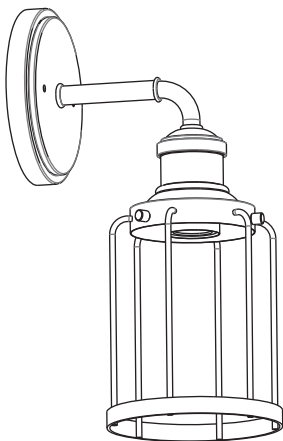

**A** Fixture Body  
x 1



**B** Glass Shade  
x 1

**MOUNTING HARDWARE**

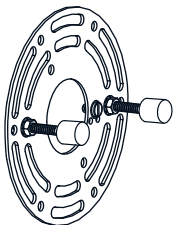

**AA** Crossbar Assembly  
x 1



**BB** Alternate  
Mounting Screw  
x 2

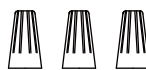

**CC** Wire Connector  
x 3



**DD** Outlet Box Screw  
x 2

# INSTALLATION

## 1 Install Crossbar Assembly

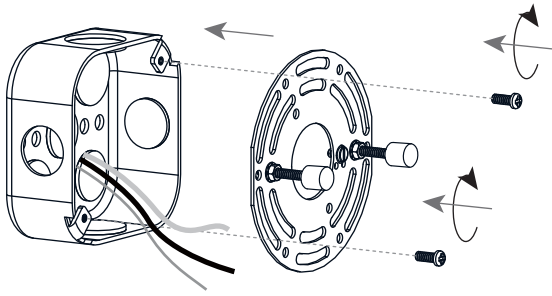

(2) Alternative Screws



\* Alternative screws are provided to replace pre-assembled mounting screws if necessary.

## 2 Wiring

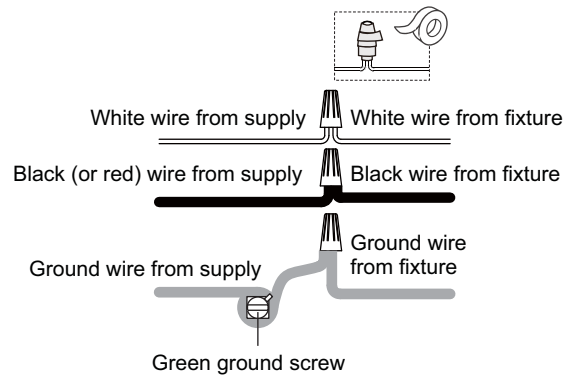

## 3 Install Fixture Body

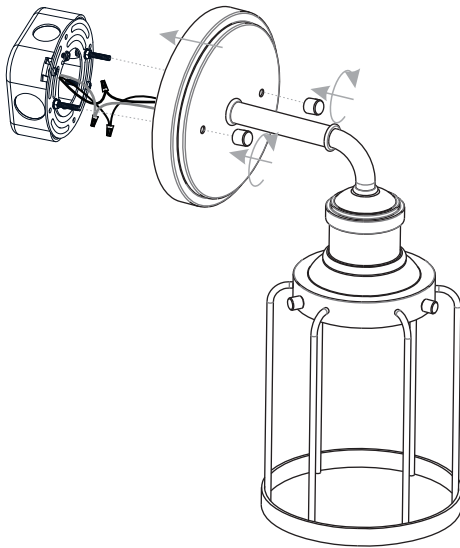

## 4 Install Bulb and Glass Shade

Install the correct bulb referring to fixture markings and/or labels for maximum wattage.

**Recommended Bulb Type(not included):**

  
BULB BASE TYPE  
Medium (E26)

  
100W  
MAX  
BULB TYPE  
TYPE A

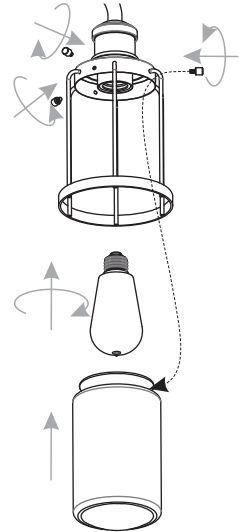

**Your installation is now complete! Restore electricity and save this sheet for future reference.**