

Tools Required

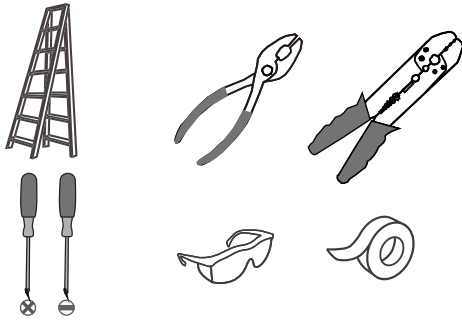

Light Source

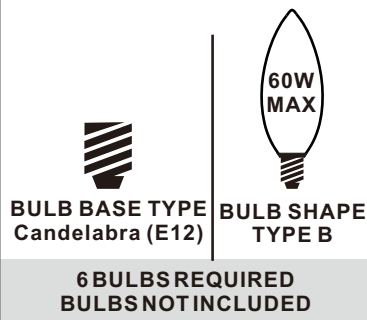

**Fixture Height Adjustable
15.5" to 45.75"**

⚠ Warnings and Cautions

Turn off the electricity at the circuit breaker before installation. Consult a licensed electrician if in doubt about installation.

Turn off power to the fixture and allow the bulbs to cool before replacing.

Package Contents

Preparation: Identify and inspect all parts before beginning the installation.

Missing or damaged parts? Contact your original place of purchase.

PARTS BAG

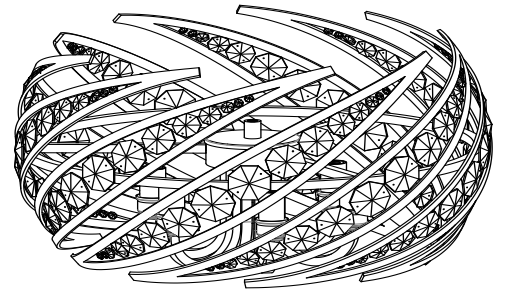
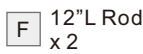
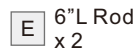
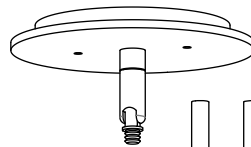
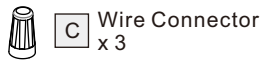
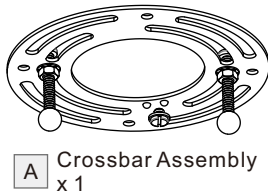

Table of Contents

Crossbar Assembly	Ceiling Canopy Assembly & Downrod	Lanyard	Wiring	Ceiling Canopy	Bulb
STEP 1	STEP 2	STEP 3	STEP 4	STEP 5	STEP 6

STEP 1

1

Step 1
Install crossbar assembly

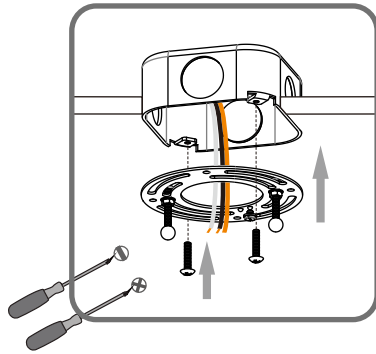

2

Step 2 - 3
Test fitting ceiling canopy to mounting screws

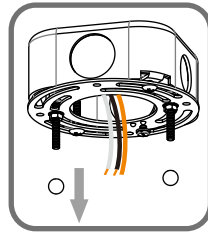

3

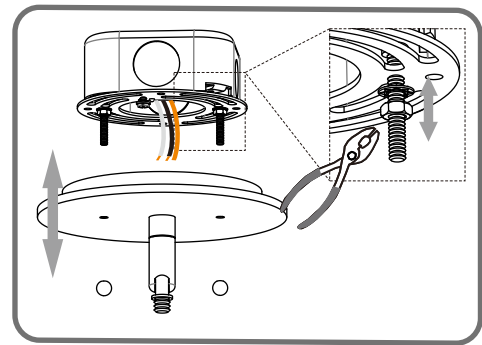

STEP 2

OPTION 1

Pendant — PCCN2824PK

Optional Rods

- 8' ceiling:
(2) 12" L rods
- 9' ceiling:
(2) 6" L + (2) 12" L rods

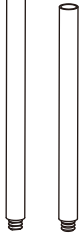

1

Install rods

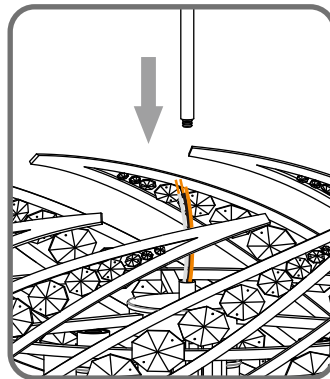

2

Tighten hex nut inside of the ceiling canopy

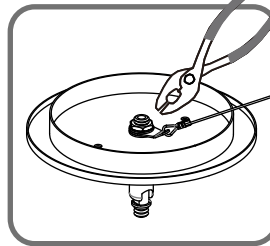

3

Install Ceiling Canopy

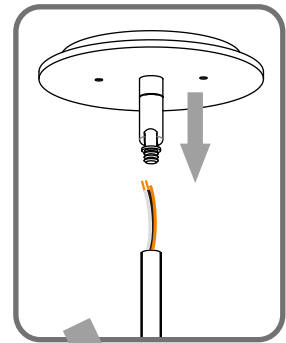

OPTION 2

Semi-flush — PCCN1724PK

1

Remove swivel

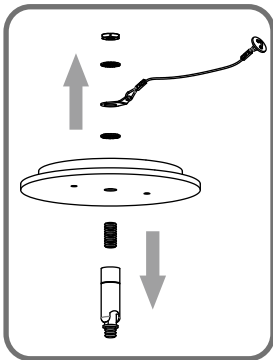

2

Install (1) 6" L rod and ceiling canopy

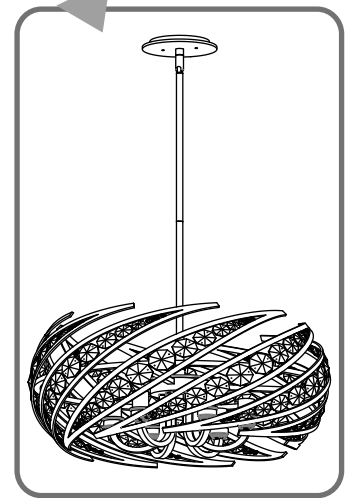
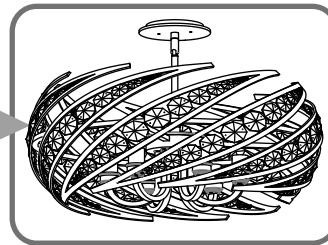
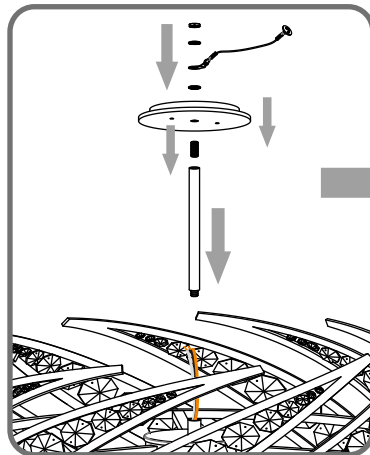

STEP 3

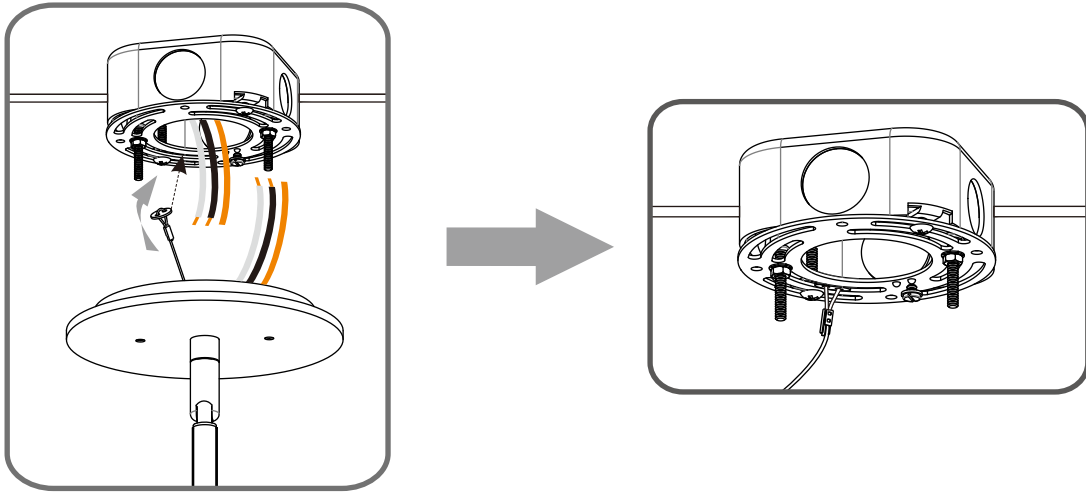

STEP 4

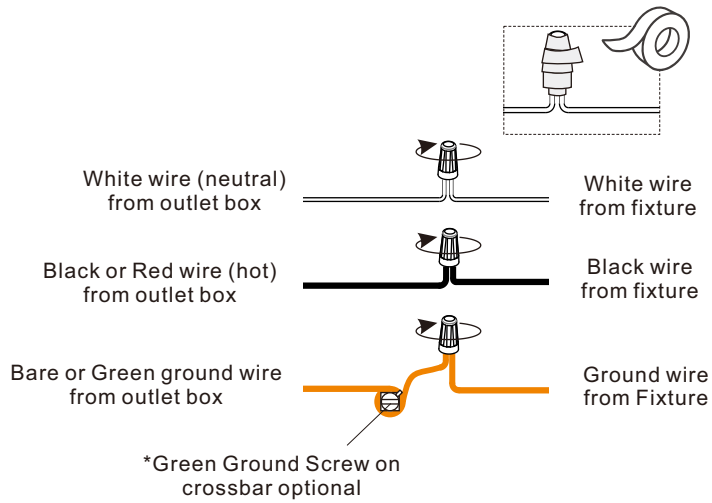

STEP 5

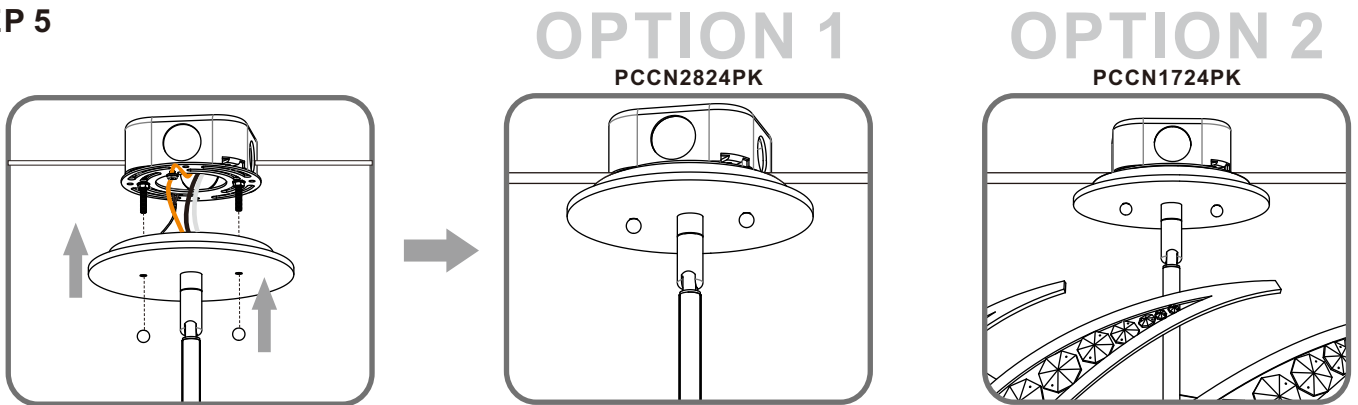

STEP 6

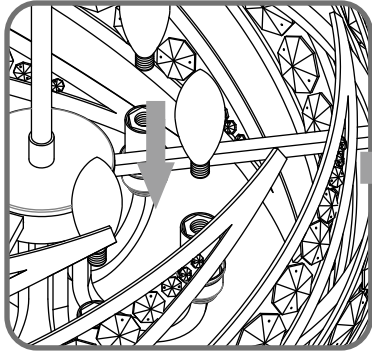

OPTION 1

PCCN2824PK

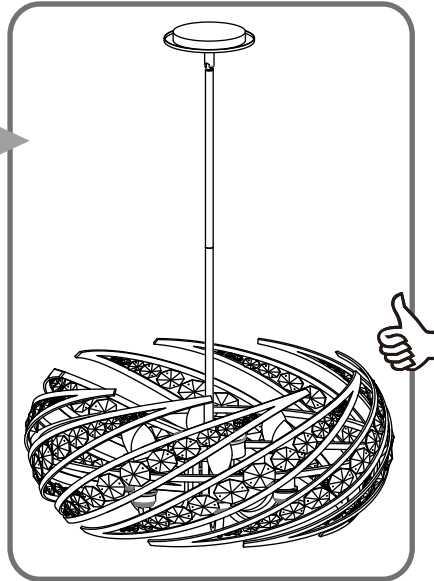

OPTION 2

PCCN1724PK

