

Please go to www.quoise.com for product cleaning tips. Go to the **Care + Maintenance** selection.

Tools Required: Flathead screwdriver, Phillips screwdriver, pliers, wire cutters, wire strippers, electrical tape, safety glasses.

Light Source: (5) B10 Candelabra Base bulbs 60W Maximum, bulb not included.

Fixture Hanging Height: Minimum Hanging Height is 24.25", Maximum Hanging Height is 73.75".

Estimated Assembly Time: 30-45 minutes

Preparation: Identify and inspect all parts before beginning installation. Check package content list and diagrams below to ensure all parts are present. If any parts are missing or damaged, do not attempt to assemble, install, or operate the fixture. Missing Parts? Contact your original place of purchase.

⚠ Warnings and Cautions

Turn off electricity at circuit breaker or main fuse box before installation. Consult a licensed electrician if in doubt.

These instructions are provided for your safety. It is very important you read them completely before installing the fixture. We strongly recommend that a licensed, professional electrician perform the installation.

Disconnect fixture from power source before replacing bulbs. Make sure bulbs are given sufficient time to cool before removal.

Package Contents

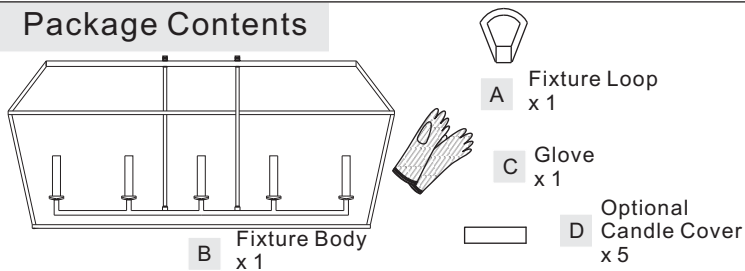

Hardware Contents

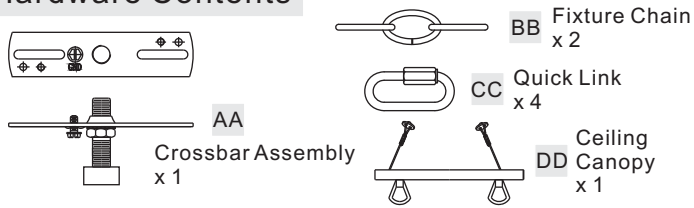

Before you start, wear Gloves (C) to keep product stay away from dirty during installation.

STEP 1 – Install the Crossbar Assembly to Outlet Box and Adjust the length of the Nipple

- Attach the Crossbar Assembly (AA) to the Outlet Box with the head of the Green Ground Screw facing you. Secure it with Outlet Box Screws (not included), tighten until snug.
- Adjust the hex nut and lock washer underside of the crossbar to the middle of the nipple.
- Remove the Lock Ball and Hex Nut from the Nipple. Place the Ceiling Canopy over the Nipple against the ceiling to determine the correct position of the nipple. Thread the Finial onto the Nipple. Adjust the nipple to allow the Ceiling Canopy to rest against the ceiling when held in place by the Lock Ball.
- Remove the Lock Ball and the Ceiling Canopy (DD). Tighten the lock washer and the hex nut against the crossbar to secure in place.

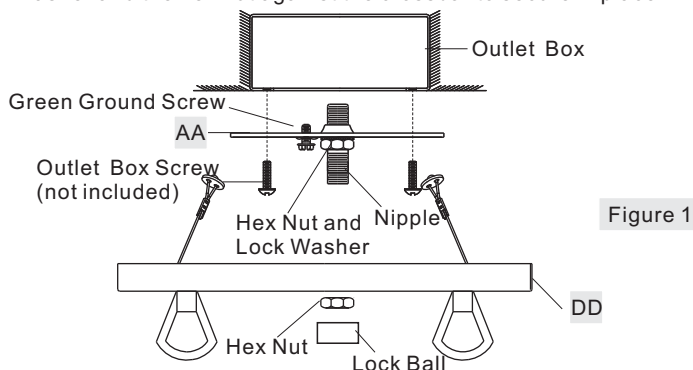

STEP 2 – Install Fixture Chains

- Thread Fixture Loop (A) onto the Nipple on the top of Fixture Body (B), hand tighten until snug.
- Adjust the Fixture Chain (BB) to your desired length by removing the links if needed.
- With the Fixture Chain (BB) not attached to the fixture loops and the ceiling loops underside of the Ceiling Canopy (DD), pull the supply wires and ground wire through the Fixture Chain (BB) alternating links. After the wires are through the Fixture Chain (BB), pull the supply wires and ground wire through the Ceiling Canopy (DD).
- Attach one ends of the Fixture Chains (BB) to fixture loops with two Quick Links (CC) as shown. Lift the fixture and Fixture Chains (BB) up and attach the other ends of the Fixture Chains (BB) onto the ceiling loops underside of the Ceiling Canopy (DD) with the rest two Quick Links (CC).

Suggested rods and chain length for Ceiling height :
 8' ceiling : use 20 links of chains and 4 quick links
 9' ceiling : use 30 links of chains and 4 quick links
 10' ceiling : use 40 links of chains and 4 quick links

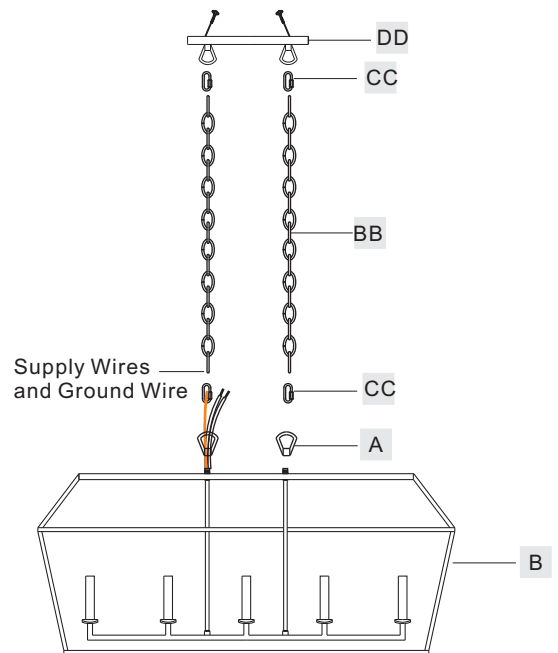

STEP 3 - Attach the Lanyard

- The purpose of the lanyard is to provide a means to support the fixture hands free from the junction box while connecting the electrical wires.
- Turn the Button Stop so it may be inserted into a Crossbar slot. Make sure the Button Stop is completely inside the Crossbar. Slowly release the fixture to make sure it is supported by the Button Stop. Proceed to the wiring steps in the next step. Once you are complete with the wiring, the Lanyard will push into the junction box when the fixture is placed for final mounting.

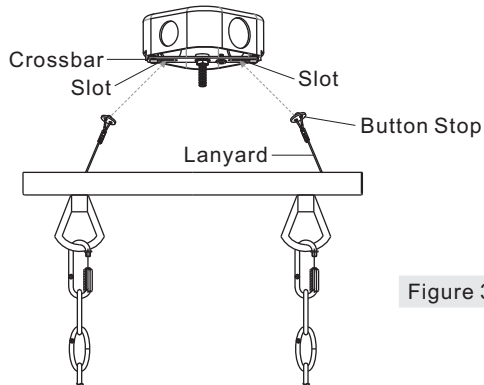

Figure 3

STEP 4 - Making the Wire Connections

- Wrap bare or green ground wire around green ground screw on the crossbar, no less than 2 inches from the end of the wire. Tighten the green ground screw.
- Use standard wire connectors (not included) to make all wire connections. Twist connectors until wires are tightly joined together. Wrap each connection with approved electrical tape and carefully stuff all the connected wires into outlet box.

Note: If the electrical wire is going to be cut shorter than provided you will need to identify the "L" line wire and the "N" neutral wire before you cut the excess wire off. One is labeled N and the other labeled L. To do this separate the "L" line wire and the "N" neutral wire as far as you need to. Re-label the wire near where you want to make the cut. Be sure to mark the wire on the side of the fixture and not on the excess wire being cut and removed.

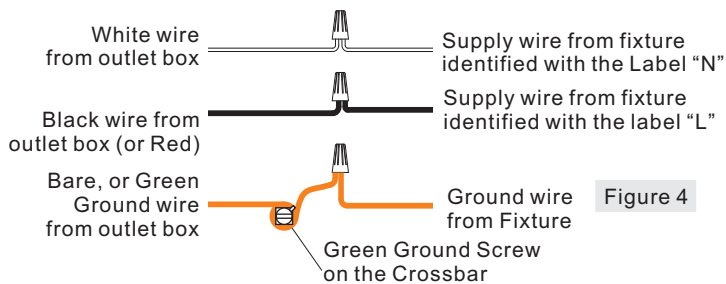

Figure 4

STEP 5 - Install Ceiling Canopy to Crossbar

- Attach the Ceiling Canopy (DD) over the end of the Nipple and secure with the Hex Nut. Hand tighten until snug.
- Thread the Lock Ball onto the Nipple and hand tighten until snug.

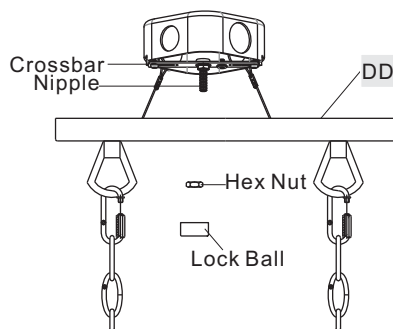

Figure 5

STEP 6 - Install the Bulb

- Insert the bulb onto the socket and screw snugly into place.

Your fixture is now assembled and ready to use. Enjoy!

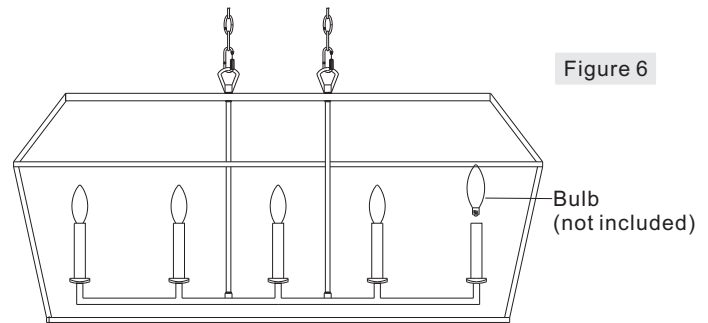

Figure 6

AVY542PK

FINISH: POLISHED NICKEL

