

Tools Required



Light Source

53W
LED

Warnings and Cautions

Turn off the electricity at the circuit breaker before installation. Consult a licensed electrician if in doubt about installation.

Turn off power to the fixture and allow the bulbs to cool before replacing.

Package Contents

Preparation: Identify and inspect all parts before beginning the installation.

Missing or damaged parts? Contact your original place of purchase.

PARTS BAG



A Crossbar
x 1



B Lock Screw
x 2



C Outlet Box Screw
x 2



D Wire Connector
x 3



E Screw
x 2



F End Cap
x 2

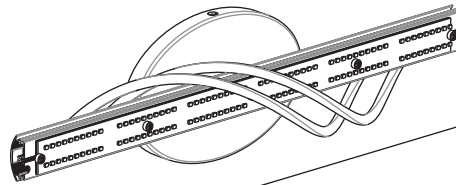

G Fixture Body
x 1

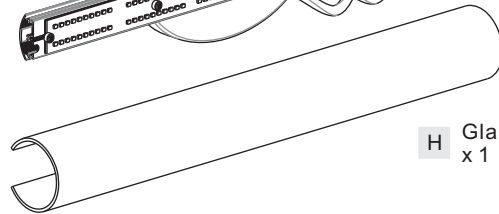

H Glass
x 1

Table of Contents

Glass, End Cap & Fixture Body

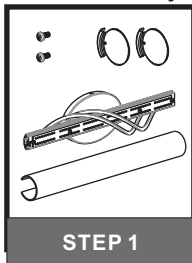

STEP 1

Crossbar

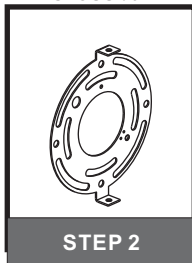

STEP 2

Wiring

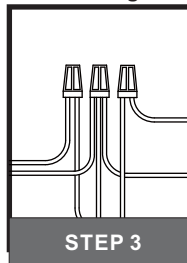

STEP 3

Fixture Body

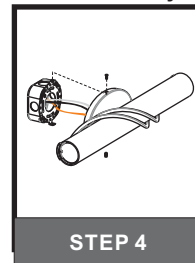

STEP 4

STEP 1

1

Install One End Cap

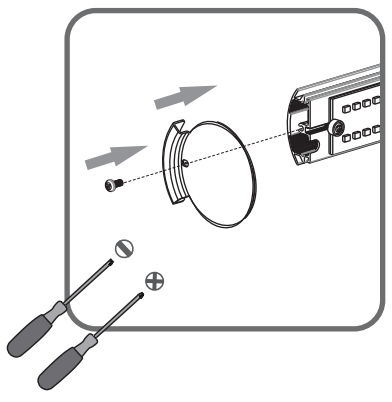

2

Install Glass and another End Cap

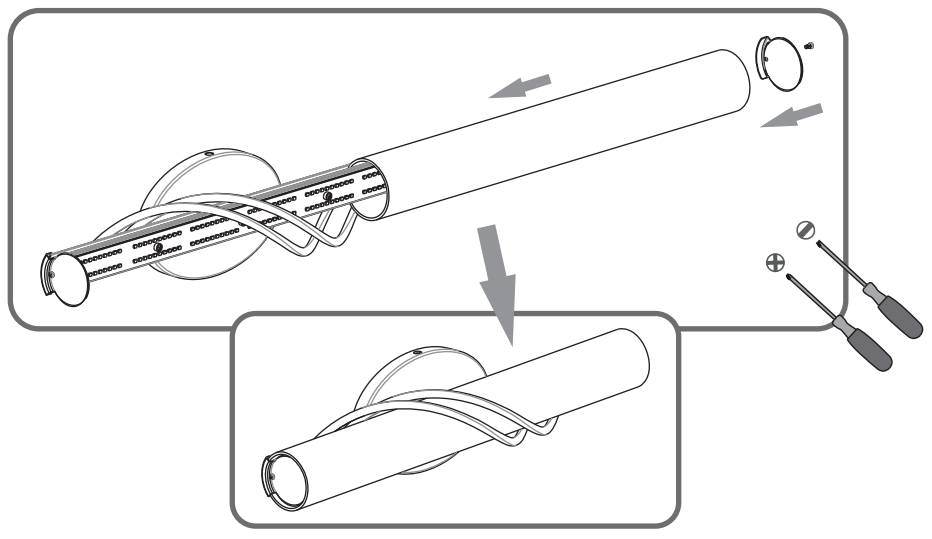

STEP 2

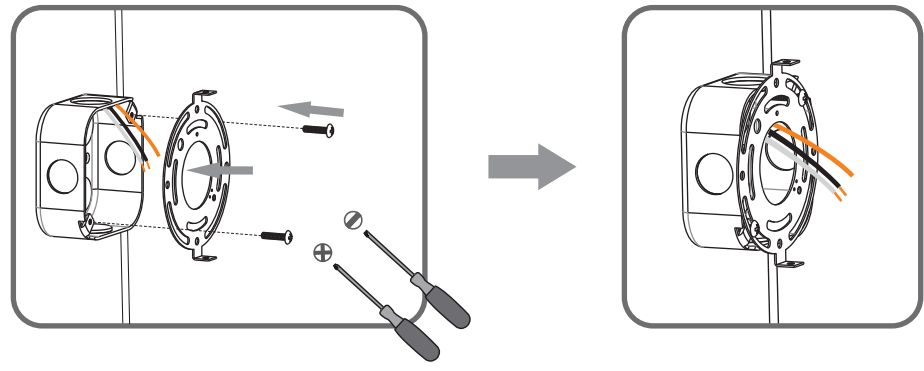

STEP 3

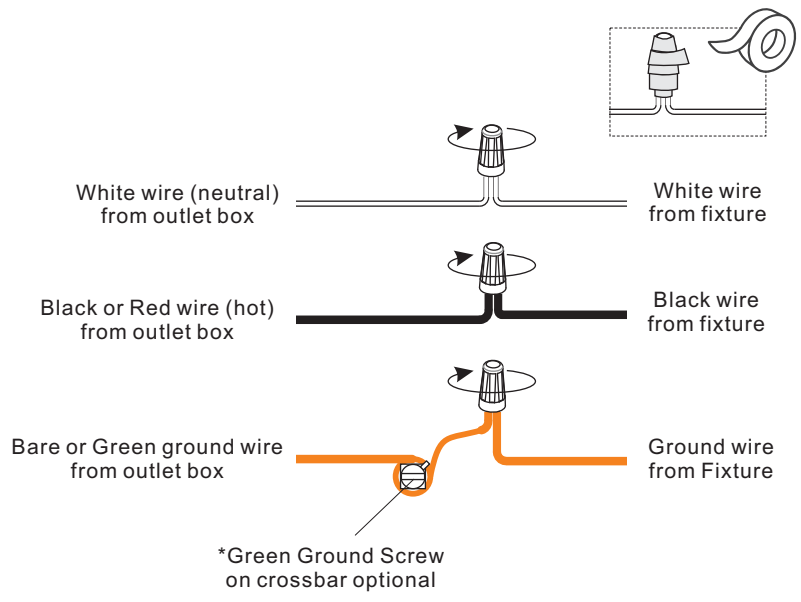

STEP 4

