

Tools Required

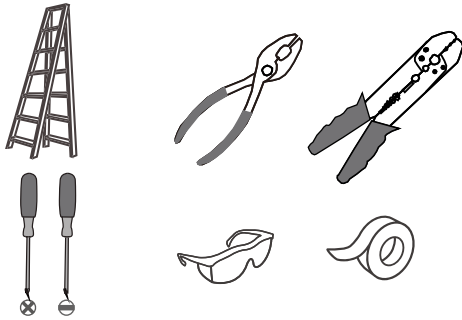

Light Source

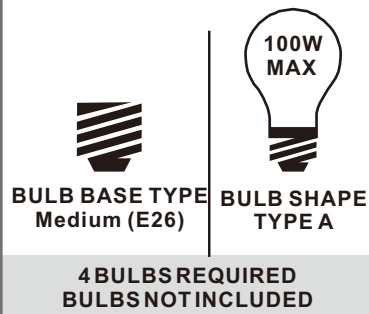

Fixture Height Adjustable 13.75" to 49.75"

Warnings and Cautions

Turn off the electricity at the circuit breaker before installation. Consult a licensed electrician if in doubt about installation.

Turn off power to the fixture and allow the bulbs to cool before replacing.

Package Contents

Preparation: Identify and inspect all parts before beginning the installation.

Missing or damaged parts? Contact your original place of purchase.

PARTS BAG

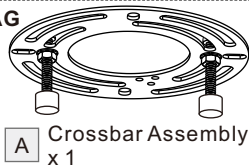

A Crossbar Assembly x 1



B Outlet Box Screw x 2



C Wire Connector x 3

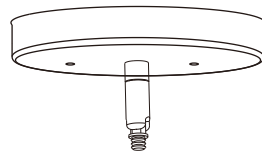

D Ceiling Canopy x 1



E 6" L Rod x 2



F 12" L Rod x 2

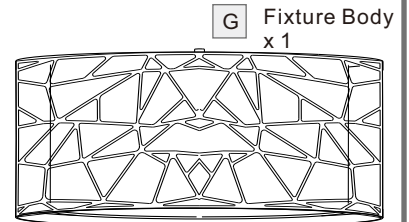

G Fixture Body x 1

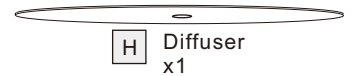

H Diffuser x 1

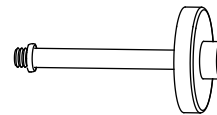

I Stem Assembly x 1

Table of Contents

Crossbar Assembly

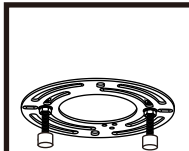

STEP 1

Downrod



STEP 2

Lanyard

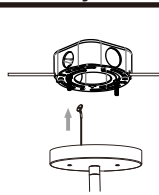

STEP 3

Wiring

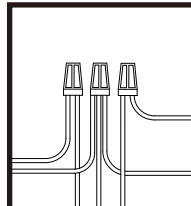

STEP 4

Ceiling Canopy

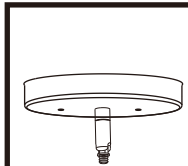

STEP 5

Bulb and Diffuser



STEP 6

STEP 1

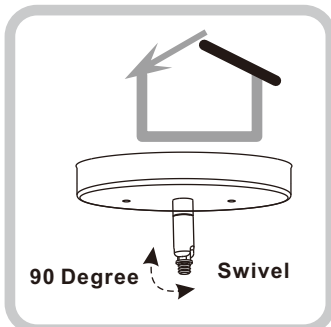

90 Degree Swivel

For angled ceilings, Swivel opening towards wall.

1

Step 1
Install crossbar assembly

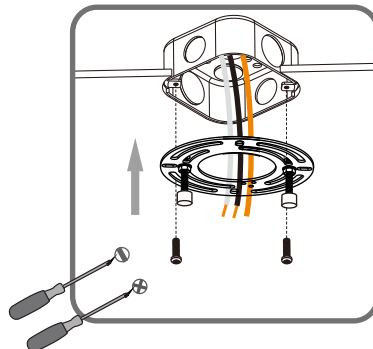

2

Step 2 - 3
Test fitting ceiling canopy to mounting screws

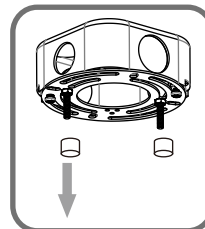

3

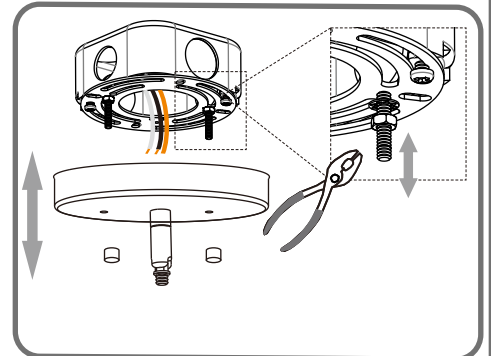

STEP 2

Optional Rods

- 8' ceiling:
(2) 6"L rods
- 9' ceiling:
(2) 6"L + (1) 12"L rods
- 10' ceiling:
(2) 6"L + (2) 12"L rods

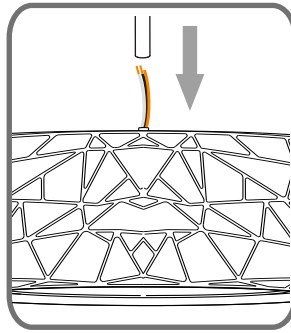

OPTION 1

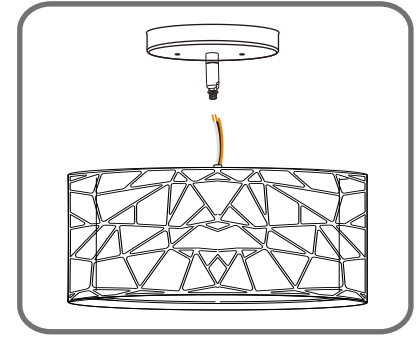
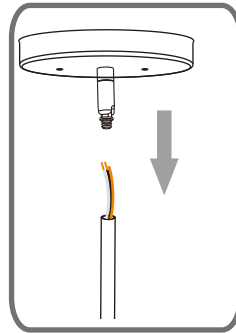

OPTION 2

STEP 3

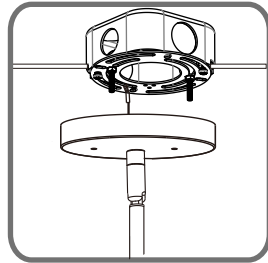
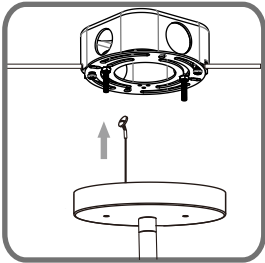

STEP 4

- White wire (neutral)
from outlet box
- Black or Red wire (hot)
from outlet box
- Bare or Green ground wire
from outlet box

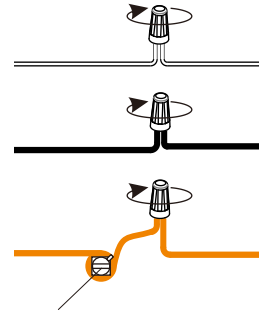

White wire
from fixture

Black wire
from fixture

Ground wire
from Fixture

*Green Ground Screw on crossbar optional

STEP 5

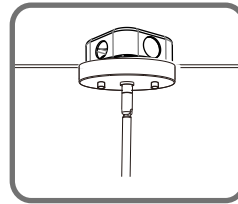
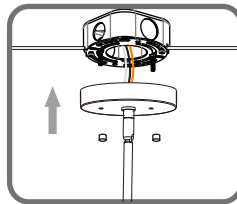

STEP 6

1

2

3

