

Tools Required

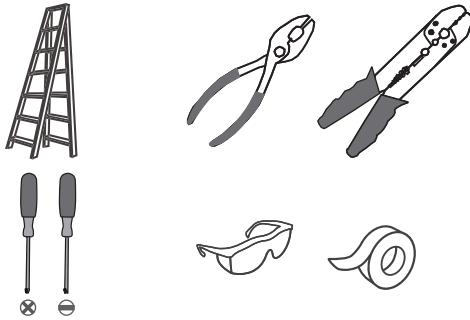

Light Source

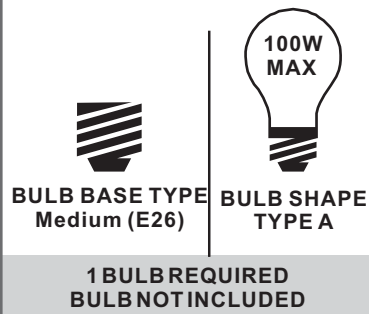

**Fixture Height Adjustable
15.25" to 51.25"**

Warnings and Cautions

Turn off the electricity at the circuit breaker before installation. Consult a licensed electrician if in doubt about installation.

Turn off power to the fixture and allow the bulbs to cool before replacing.

Package Contents

Preparation: Identify and inspect all parts before beginning the installation.

Missing or damaged parts? Contact your original place of purchase.

PARTS BAG

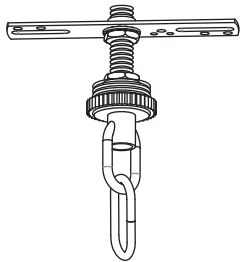

A Crossbar Assembly x 1



B Quick Link x 1

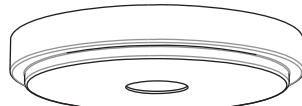

C Ceiling Canopy x 1



D Outlet Box Screw x 2



E Wire Connector x 3



F Small Loop x 1

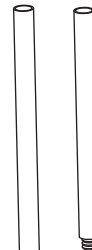

G 6" L Rod x 2

H 12" L Rod x 2

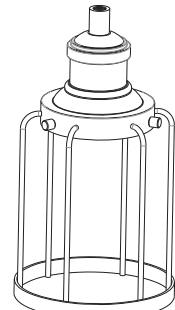

I Fixture Body x 1



J Shade x 1

Table of Contents

Rods & Small Loop

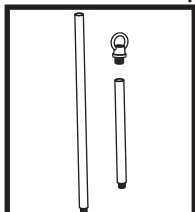

STEP 1

Crossbar Assembly

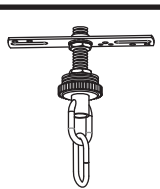

STEP 2

Quick Link



STEP 3

Wiring

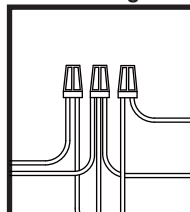

STEP 4

Ceiling Canopy

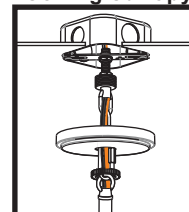

STEP 5

Bulb & Shade

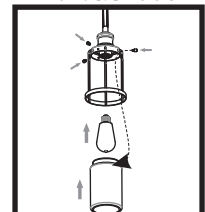

STEP 6

STEP 1

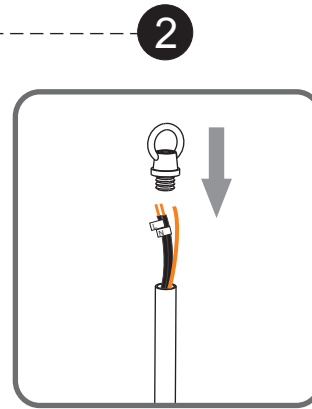
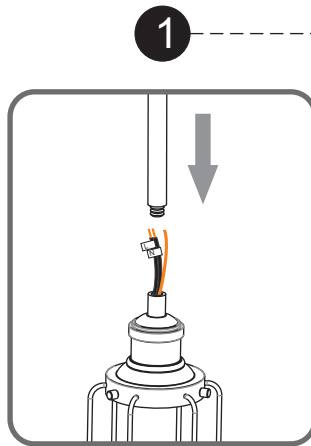
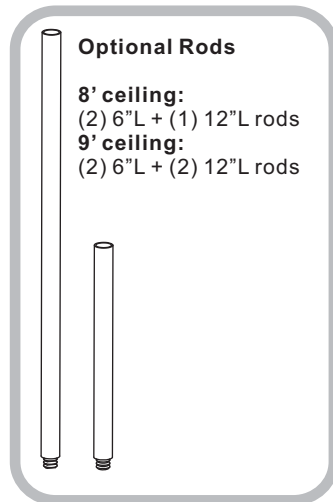

STEP 2

1

Step 1
Install crossbar assembly

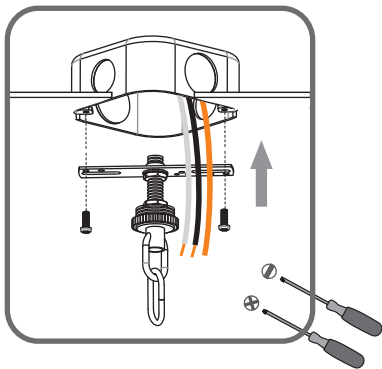

2

Step 2 - 3
Test fitting ceiling canopy to nipple

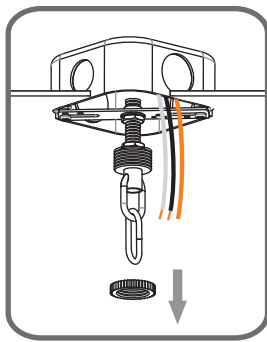

3

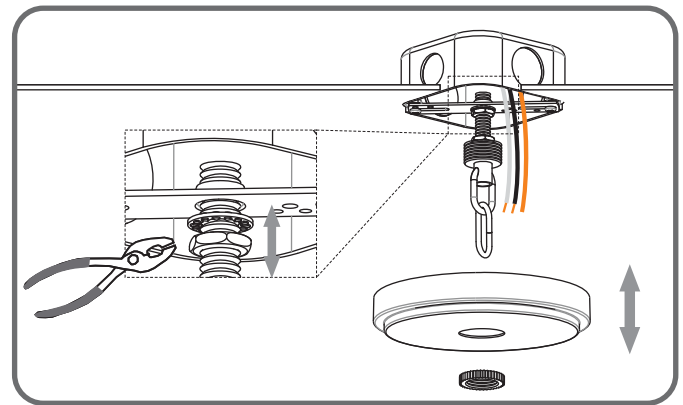

STEP 3

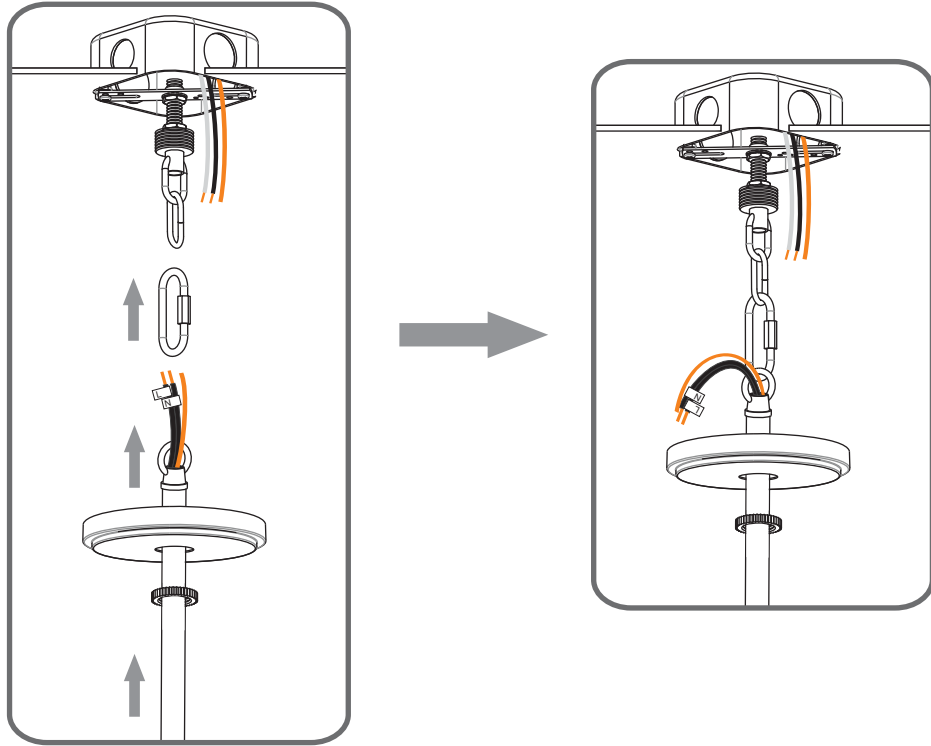

STEP 4

1

Step 1
Feed the fixture wires
through the loop

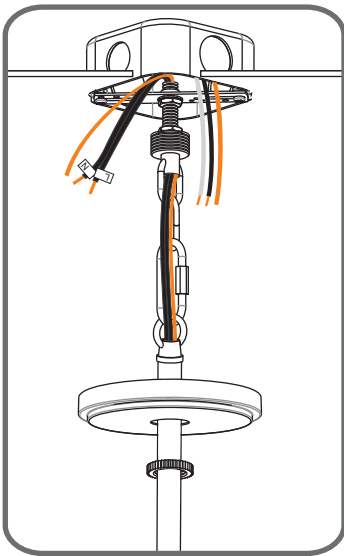

2

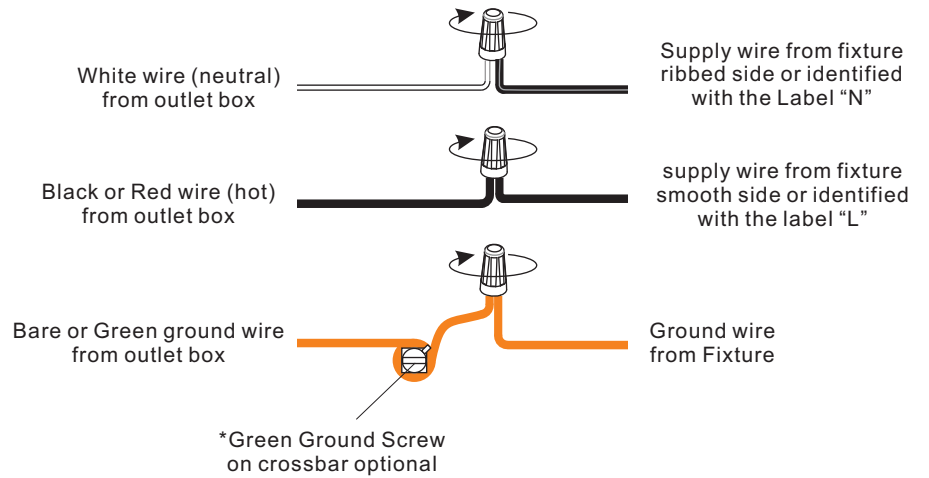

STEP 5

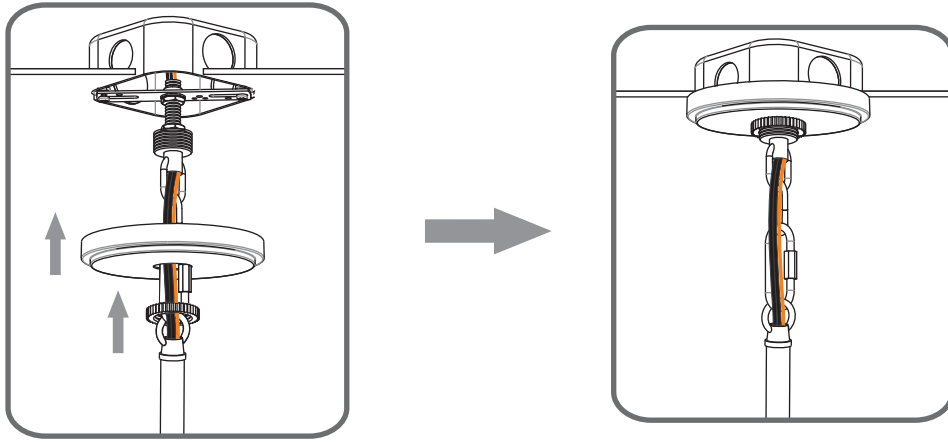

STEP 6

