

Please go to www.quoise.com for product cleaning tips. Go to the **Care + Maintenance** selection.

Tools Required: Flathead screwdriver, Phillips screwdriver, pliers, wire cutters, wire strippers, electrical tape, safety glasses, marking pen, 1/4" drill bit and drill.

Light Source: (3) A19 Medium Base Bulbs 100W Maximum, bulbs not included.

Fixture Hanging Height: Minimum Hanging Height is 19.5", Maximum Hanging Height is 111.5".

Estimated Assembly Time: 30-45 minutes

Preparation: Identify and inspect all parts before beginning installation. Check package content list and diagrams below to be sure all parts are present. If any parts are missing or damaged, do not attempt to assemble, install, or operate the fixture. Contact your original place of purchase.

⚠ Warnings and Cautions

Turn off electricity at circuit breaker or main fuse box before installation. Consult a licensed electrician if in doubt.

These instructions are provided for your safety. It is very important you read them completely before installing the fixture. We strongly recommend that a licensed, professional electrician perform the installation.

Disconnect fixture from power source before replacing bulbs. Make sure bulbs are given sufficient time to cool before removal.

Package Contents

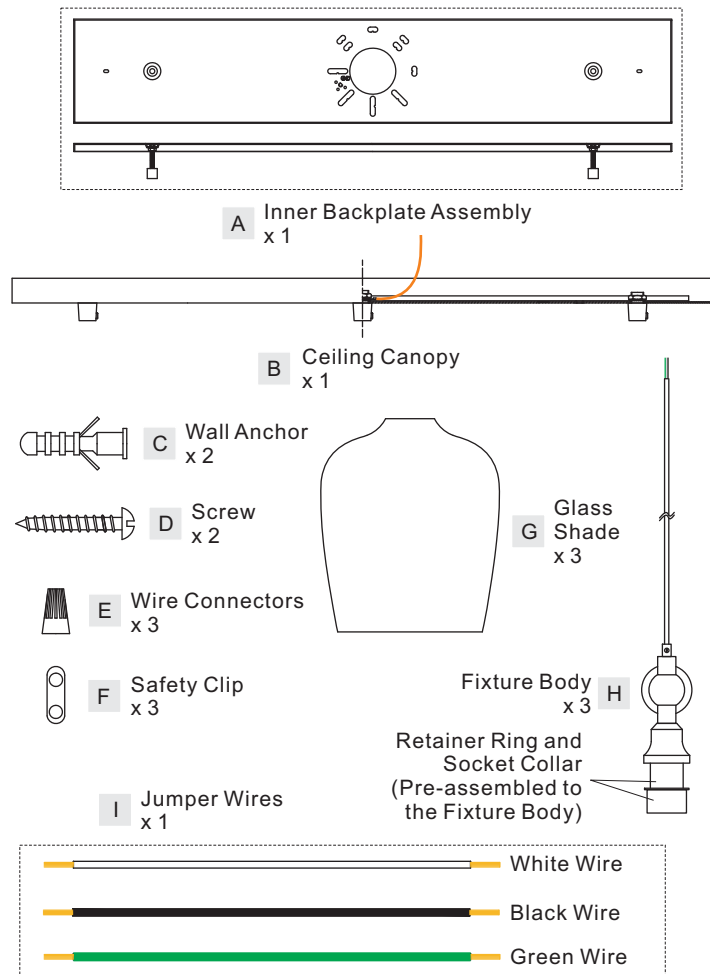

STEP 1 - Install Fixture Bodies to Ceiling Canopy

- Loosen set screws located on the couplings that are mounted to the underside of the Ceiling Canopy (B). Do not remove set screws completely.
- Place cord through the coupling mounted to the underside of the Ceiling Canopy (B). Adjust cord to the desired length then tighten set screw to hold pendant length in place.
- Install safety clip onto the pendant cords by threading the cord through one hole then back through the second. Slide safety clip to approximate 2" from canopy.
- Repeat these steps for all pendants.
- After the ceiling canopy is installed to the junction box, a final adjustment can be made to get the pendants to hang at the desired height by loosening the set screws on the coupling slightly then re-tighten when the pendants are adjusted to the desired height.

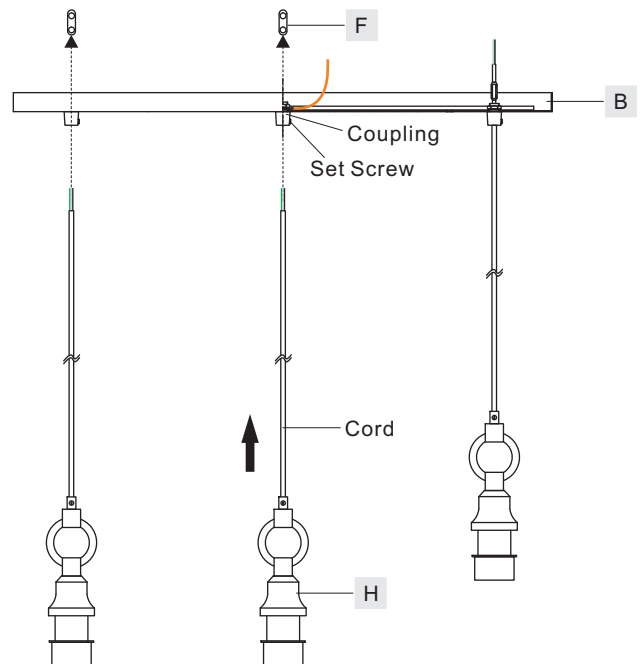

Figure 1

Please measure the height you want to hang the pendant prior to hanging so you know what length to cut the wire. You can add 6" to that length to help adjust the shades up or down once it's hung. Please note, all the extra wire will not fit inside the small canopy and junction box, the wire needs to be cut at the desired length to fit inside the canopy and junction box to then help adjust to the exact height.

IMPORTANT: Install the cord into the ceiling canopy before cutting it to length.

STEP 2 - Connections Fixture Wires to Jumper Wires

- Strip back the clear wire covering on the 3 pendant cords to expose the black, white and green wire. Leave at least approximately 3" of cord length inside of the ceiling canopy. Strip each end of 3 fixture wires.
- Use supplied wire connectors (E) to connect fixture wires to Jumper Wires (I). Twist connectors until wires are tightly joined together. Wrap each connection with approved electrical tape.

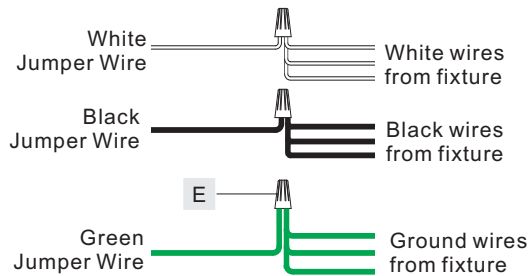

Figure 2

STEP 3 - Attach Inner Backplate Assembly to Outlet Box

- Attach the Inner Backplate Assembly (A) onto the outlet box and make two marks on the ceiling from a set of slot keyholes.
- Remove the Inner Backplate Assembly (A). Using a 1/4" drill bit, drill holes at each (2) locations marked on the ceiling.
- Insert Wall Anchors (B) into drilled holes completely.
- Pass supply wires and ground wire through the center hole of the Inner Backplate Assembly (A). Attach the Inner Backplate Assembly (A) to outlet box. Thread outlet box screws (not included) into mounting holes on the outlet box and thread Screws (C) into Wall Anchors (B). Hand tighten until snug with screwdrivers.

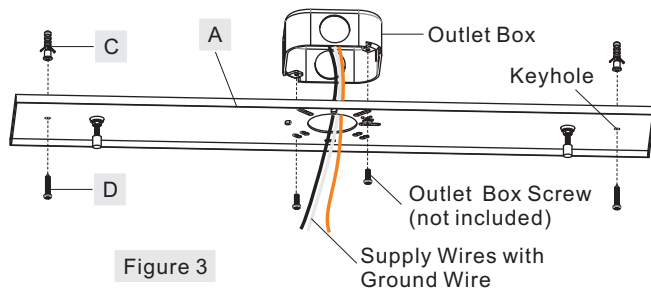

Figure 3

STEP 4 - Test Fitting Ceiling Canopy to Inner Backplate Assembly

- Remove mounting balls from the mounting screws. Fit the Ceiling Canopy (B) to the mounting screws on the Inner Backplate (A) and secure with mounting balls. Note: The Ceiling Canopy (B) should be snug against the ceiling and the mounting balls. If not, adjust the length of the nipple on the Inner Backplate (A) by unscrewing the preassembled hex nut and lock washer and then screwing the mounting screws in or out of the crossbar until the correct length is achieved. Once the Ceiling Canopy (B) is secure, remove the mounting ball and Ceiling Canopy (B) and proceed to Step 5.

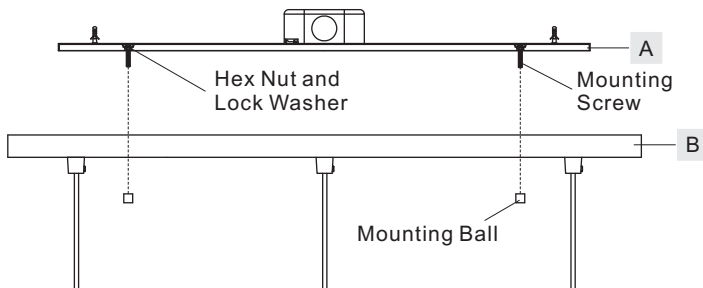

Figure 4

STEP 5 - Wire Connections

- Wrap bare or green ground wire around green ground screw on the crossbar, no less than 2 inches from the end of the wire. Tighten the green ground screw.
- Use standard wire connectors (not included) to make all wire connections. Twist connectors until wires are tightly joined together. Wrap each connection with approved electrical tape and carefully stuff all the connected wires into the Outlet Box.

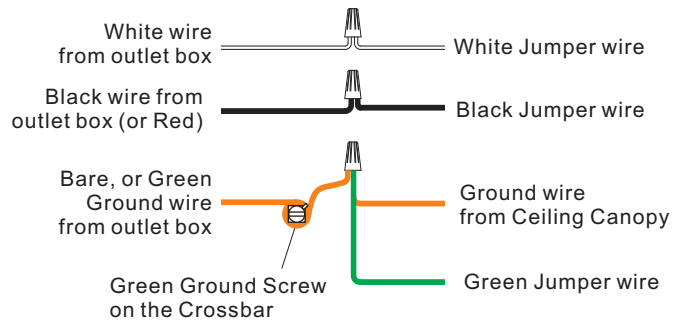

Figure 5

STEP 6 - Install Ceiling Canopy

- Carefully tuck all wires into the outlet box and position the Ceiling Canopy (B) over the outlet box. Attach the Ceiling Canopy (B) over the mounting screws and secure with previously removed mounting balls. Hand tighten until snug.

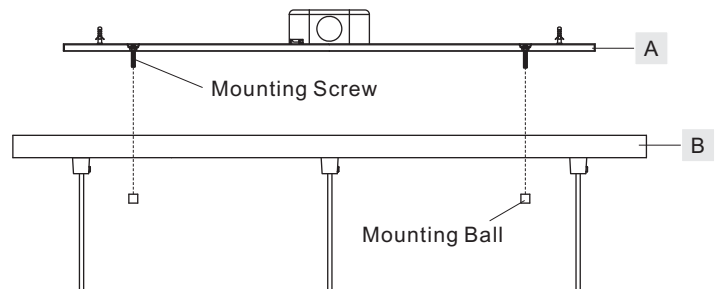

Figure 6

STEP 7 - Install Glass Shades and Bulbs

- Remove socket collars and retainer rings from Fixture Body (H).
- Place the Glass Shade (G) and the retainer ring onto the socket and secure with the socket collar. Hand tighten until snug.
- Insert bulbs onto sockets and screw snugly into place.

Your fixture is now assembled and ready to use. Enjoy!

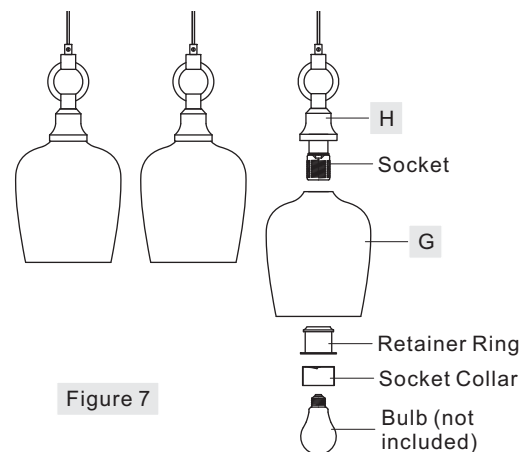
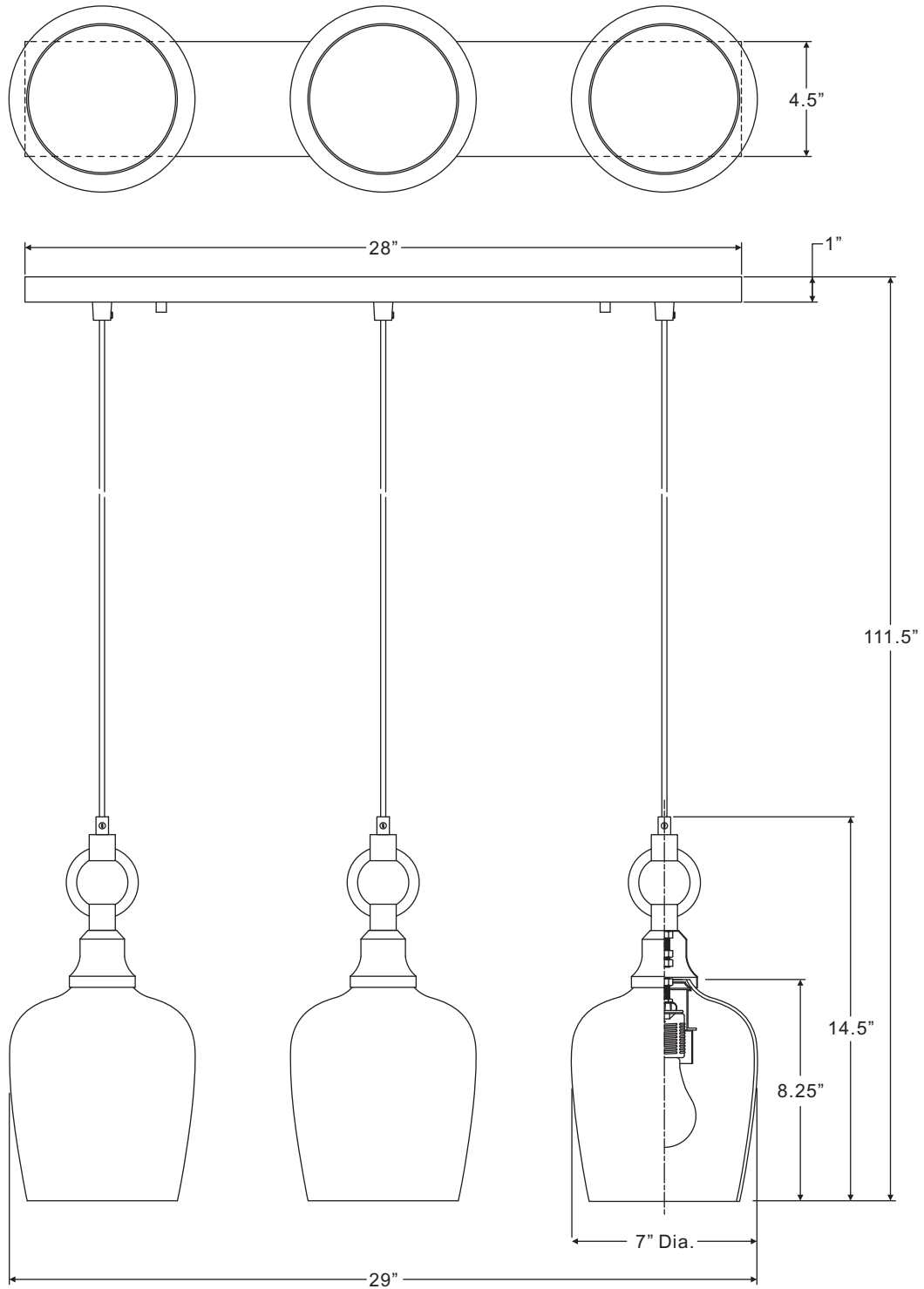
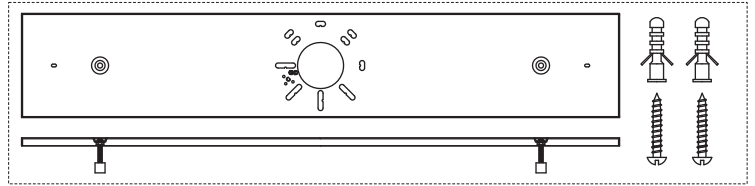

Figure 7

CKKD329WT

FINISH: WESTERN BRONZE



NOTE: ALL DIMENSIONS ARE ROUNDED UP TO THE NEAREST 1/4"