

Tools Required

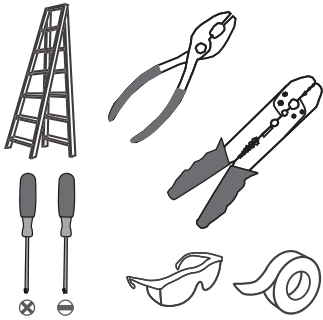

Light Source

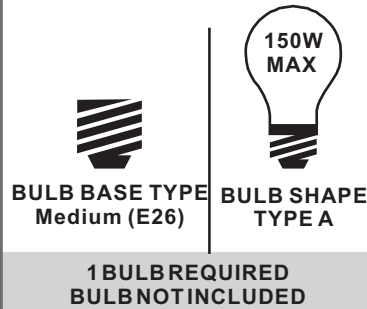

Warnings and Cautions

Turn off the electricity at the circuit breaker before installation. Consult a licensed electrician if in doubt about installation.

Turn off power to the fixture and allow the bulbs to cool before replacing.

Package Contents

Preparation: Identify and inspect all parts before beginning the installation.

Missing or damaged parts? Contact your original place of purchase.

PARTS BAG

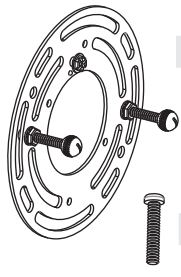

A Crossbar Assembly x 1

B Alternate Mounting Screw x 2



C Outlet Box Screw x 2



D Wire Connector x 3

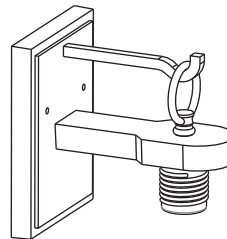

E Fixture Body x 1

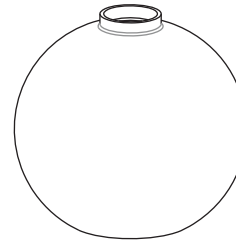

F Shade x 1

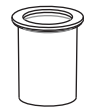

G Socket Collar x 1

Table of Contents

Alternate Mounting Screw	Crossbar Assembly	Wiring	Fixture Body	Shade & Bulb	Caulk
STEP 1	STEP 2	STEP 3	STEP 4	STEP 5	STEP 6

STEP 1

OPTION 1

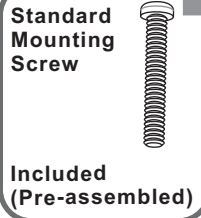

skip to next page

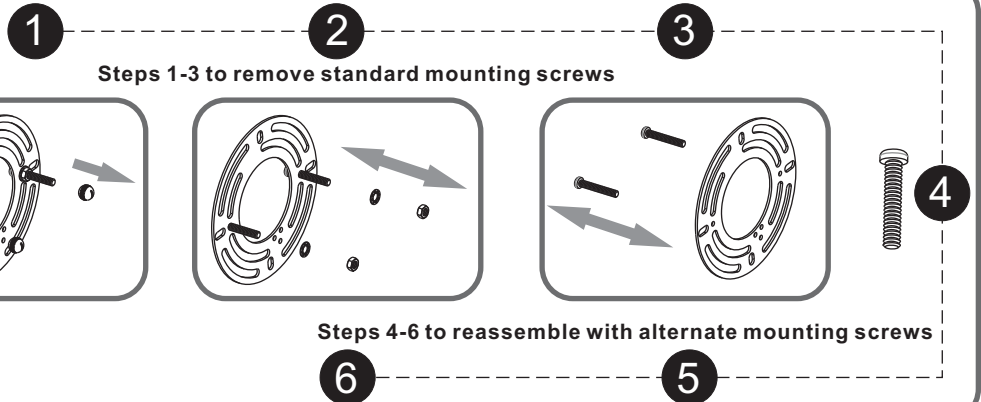

OPTION 2

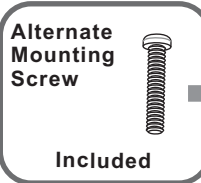

STEP 2

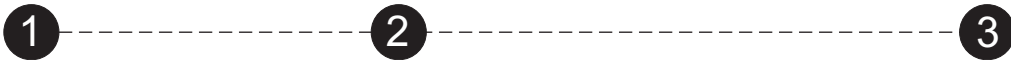

Step 1
Install crossbar assembly

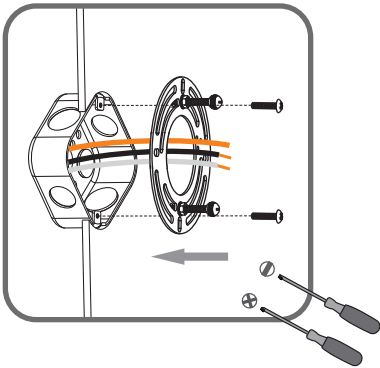

Step 2 - 3
Test fitting backplate to mounting screws

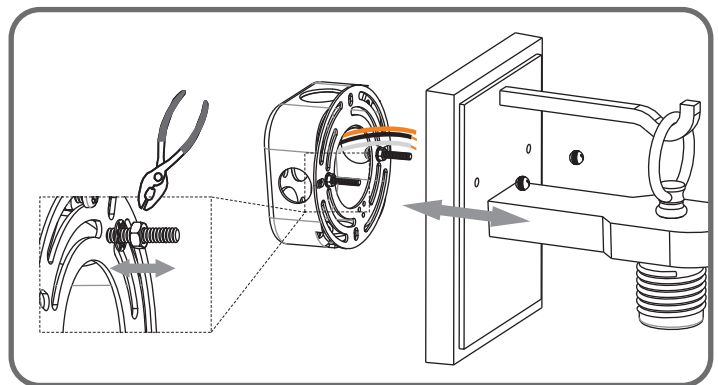
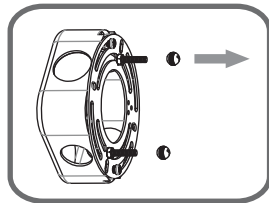

STEP 3

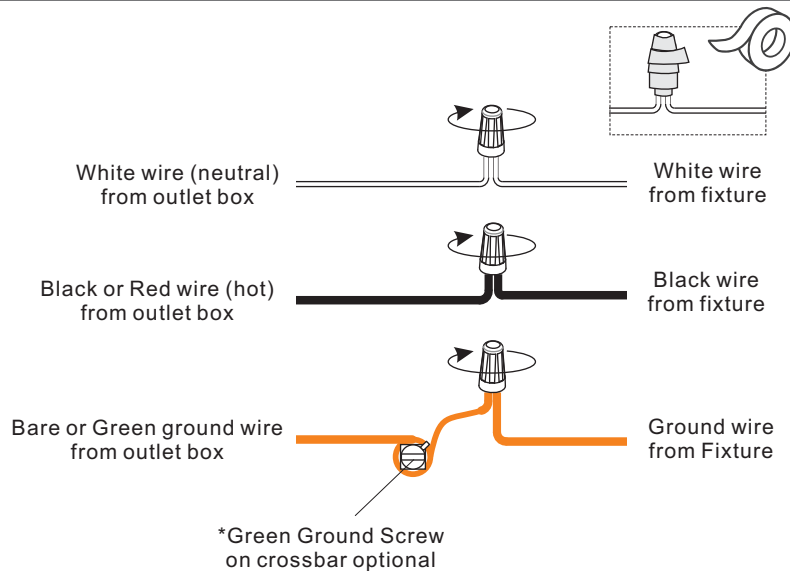

STEP 4

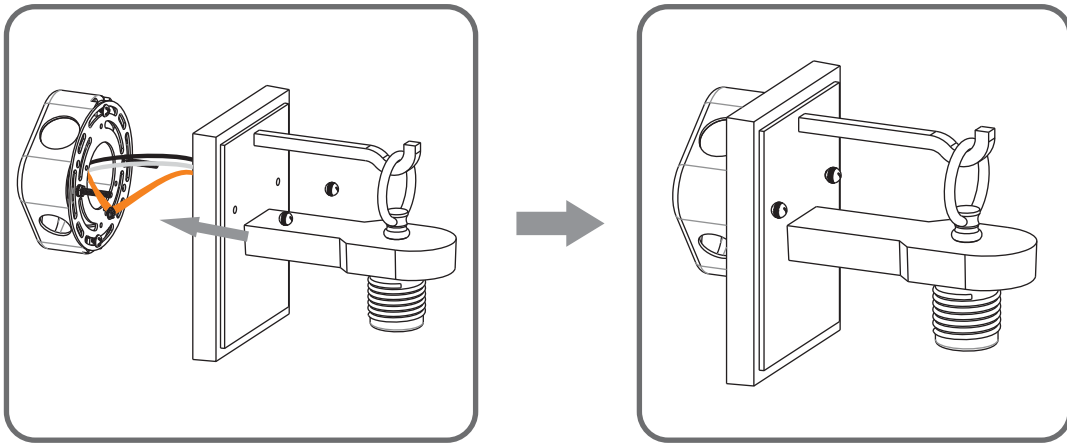

STEP 5

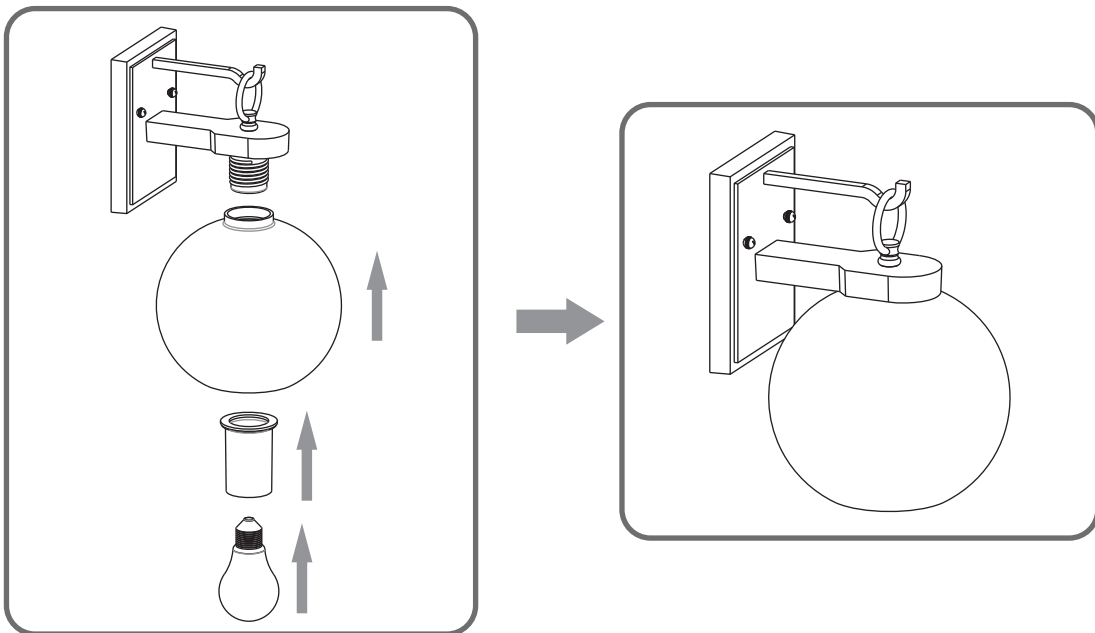

STEP 6

