

SAFETY INFORMATION

Released Date: 2021-06-19

Please read and understand this entire manual before attempting to assemble, install or operate the product.

WARNING

- RISK OF ELECTRIC SHOCK - Before beginning installation, turn off electricity at the circuit breaker box or the main fuse box.
- RISK OF FIRE - Use bulbs specified by the markings and/or labels on the fixture.

CAUTION

- For your safety, read instructions completely before beginning installation.
- If in doubt about electrical installation, consult a licensed electrician.
- Turn off electricity to fixture before replacing the bulb(s).

TOOLS REQUIRED

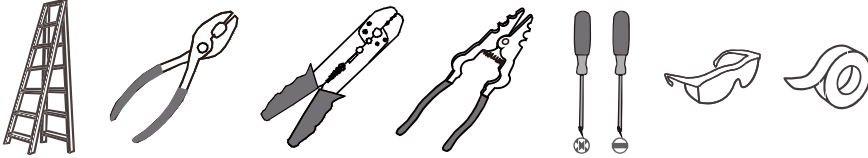

CARE AND MAINTENANCE

- Wipe clean using soft, dry cloth or static duster. Always avoid using harsh chemicals and abrasives to clean fixture as they may damage the finish.

If you need further assistance call Quozel Customer Care at 1-800-645-3184 (9:00am – 5:00pm EST), or visit us on-line at www.quozel.com.

PACKAGE CONTENTS

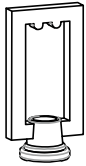

A Fixture Loop
x 1

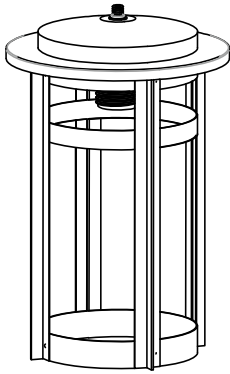

B Fixture Body
x 1



C Glass Shade
x 1



D Socket Collar
[pre-assembled to Fixtrure Body]
x 1

MOUNTING HARDWARE

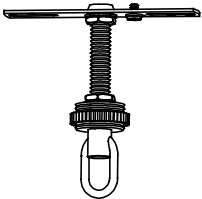

AA Crossbar Assembly
x 1

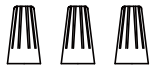

BB Wire Connector
x 3



CC Outlet Box Screw
x 2

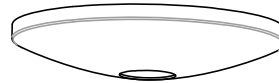

DD Ceiling Canopy
x 1



EE Quick Link
x 2



FF Fixture Chain
x 1

INSTALLATION

1 Install Fixture Loop

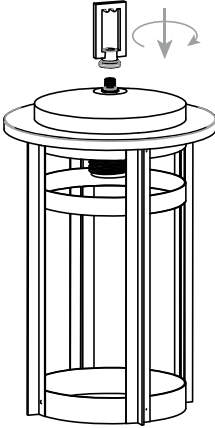

A line drawing of a cylindrical fixture housing with a top cap. A small rectangular fixture loop is being inserted into a hole in the top cap. A curved arrow indicates the direction of insertion.

2 Install Crossbar Assembly

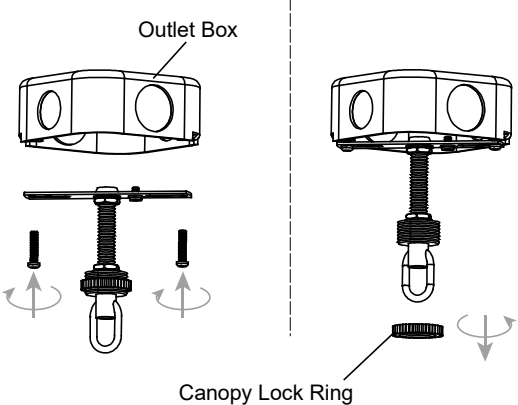

Two diagrams showing the assembly of the crossbar. The left diagram shows an 'Outlet Box' (a rectangular box with two circular openings) being attached to a crossbar. The right diagram shows the crossbar being inserted into the fixture housing, with a 'Canopy Lock Ring' being placed over the end of the crossbar. Arrows indicate the direction of assembly.

3 Install Fixture Chain

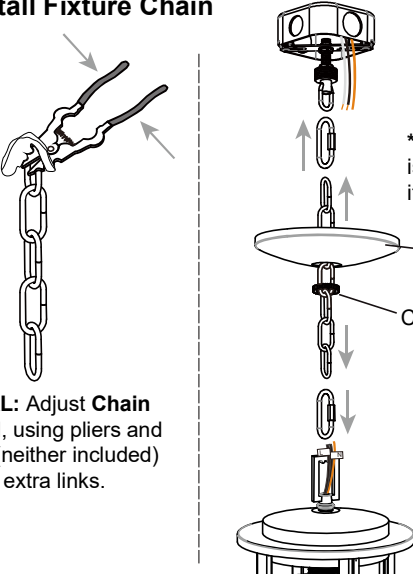

A diagram showing a chain being attached to a ceiling canopy and the fixture housing. The chain is shown in two parts: one part is being attached to the ceiling canopy, and the other part is being attached to the fixture housing. A note indicates that the ceiling canopy shape varies by item. An optional note suggests adjusting the chain length with pliers and a soft cloth.

OPTIONAL: Adjust Chain as desired, using pliers and soft cloth (neither included) to remove extra links.

* Ceiling Canopy shape is varies depends on items purchased.

Ceiling Canopy

Canopy Lock Ring

4 Pull Supply Wires

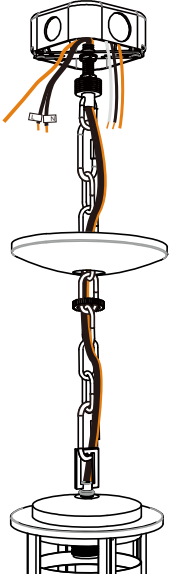

A diagram showing the supply wires (white, black, and ground) being pulled through the chain links. The wires are shown entering the fixture housing from the ceiling canopy. A note indicates that the ground wire should be pulled through the alternate links of the chain.

Pull the supply wires with ground wire through the chain alternate links.

5 Wiring

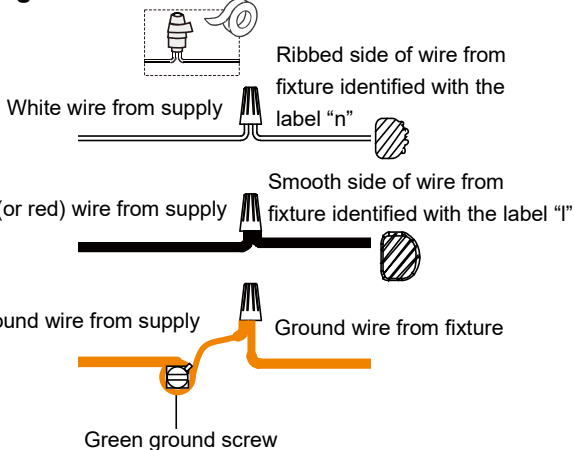

A diagram showing the wiring connections for the fixture. It shows three types of wires: a white wire from the supply connected to the ribbed side of the fixture wire (labeled 'n'); a black (or red) wire from the supply connected to the smooth side of the fixture wire (labeled 'l'); and a ground wire from the supply connected to a green ground screw on the fixture, which is also connected to the ground wire from the fixture.

Ribbed side of wire from fixture identified with the label "n"

White wire from supply

Smooth side of wire from fixture identified with the label "l"

Black (or red) wire from supply

Ground wire from supply

Ground wire from fixture

Green ground screw

6 Install Ceiling Canopy

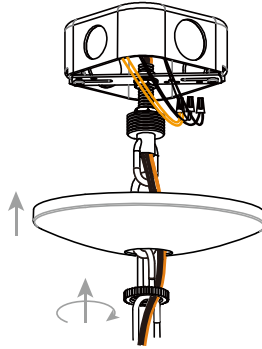

A diagram showing the ceiling canopy being installed onto the fixture housing. The canopy is shown being pushed onto the top of the fixture housing. A note indicates that the ceiling canopy shape varies by item.

* Ceiling Canopy shape is varies depends on items purchased.

INSTALLATION

7 Install Glass Shade

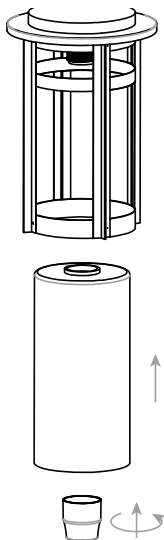

8 Install Bulb

Install the correct bulb referring to fixture markings and/or labels for maximum wattage.

Recommended Bulb type (not included):

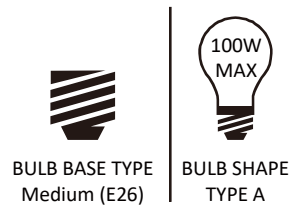

Your installation is now complete! Restore electricity and save this sheet for future reference.