

Please go to www.quoizel.com for product cleaning tips. Go to the **Care + Maintenance** selection.

Tools Required: Flathead screwdriver, Phillips screwdriver, pliers, wire cutters, wire strippers, electrical tape, safety glasses.

Light Source: (7) Medium Base Type-A bulbs (not supplied), Maximum 100W.

Fixture Hanging Height: Minimum Hanging Height is 13.5", Maximum Hanging Height is 50.25".

Estimated Assembly Time: 30-45 minutes

Preparation: Identify and inspect all parts before beginning installation. Check package content list and diagrams below to ensure all parts are present. If any parts are missing or damaged, do not attempt to assemble, install, or operate the fixture. Contact your original place of purchase.

⚠ Warnings and Cautions

Turn off electricity at circuit breaker or main fuse box before installation. Consult a licensed electrician if in doubt.

These instructions are provided for your safety. It is very important you read them completely before installing the fixture. We strongly recommend that a licensed, professional electrician perform the installation.

Disconnect fixture from power source before replacing bulbs. Make sure bulbs are given sufficient time to cool before removal.

Package Contents

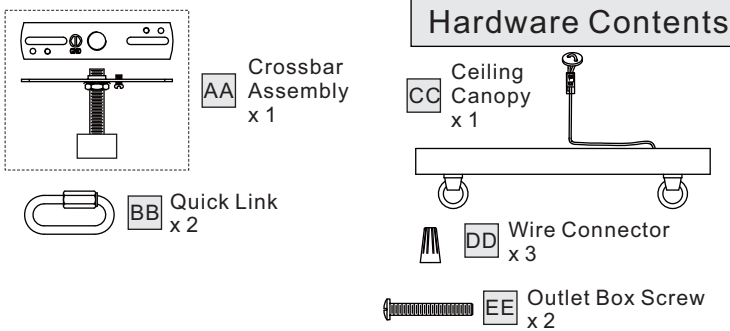
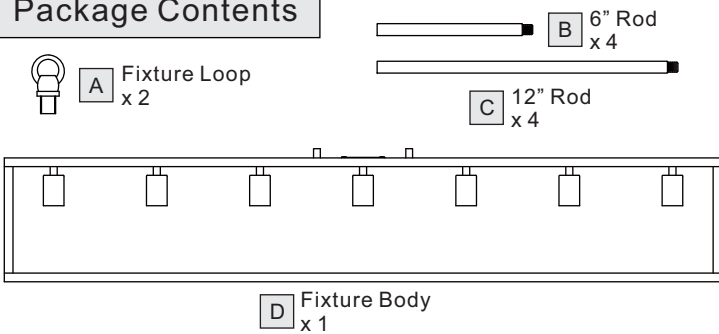

STEP 1 – Install Rods, Fixture Loop to Fixture Body

- Determine the Rods (B/C) to be assembled to the Fixture Body (D) according to your hanging height.
- Pass the supply wires and ground wire through the chosen rods (B/C) and one Fixture Loop (A). Thread the Fixture Body (D), the chosen Rods (B/C) and the Fixture Loop (A) together. Hand tighten until snug.

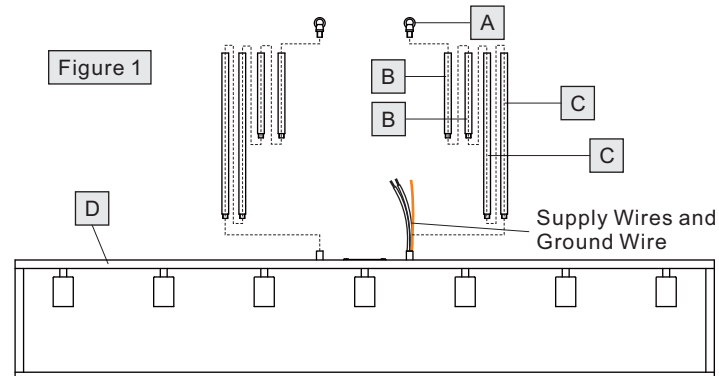

(Step 1 Continued)

Suggested rods for Ceiling height :
8' ceiling : use (2) 12" rods
9' ceiling : use (2) 6" rods and (2) 12" rods

STEP 2 – Install the Crossbar Assembly to Outlet Box and Adjust the length of the Nipple

- Attach the Crossbar Assembly (AA) to the Outlet Box with the head of the Green Ground Screw facing you. Secure it with Outlet Box Screws (EE), tighten until snug.
- Adjust the hex nut and lock washer underside of the crossbar to the middle of the nipple.
- Remove the mounting ball from the nipple. Place the Ceiling Canopy (CC) over the nipple against the ceiling to determine the correct position of the nipple. Thread the mounting ball onto the nipple. Adjust the nipple to allow the Ceiling Canopy (CC) to rest against the ceiling when held in place by the mounting ball.
- Remove the mounting ball and the Ceiling Canopy (CC). Tighten the lock washer and the hex nut against the crossbar to secure in place.

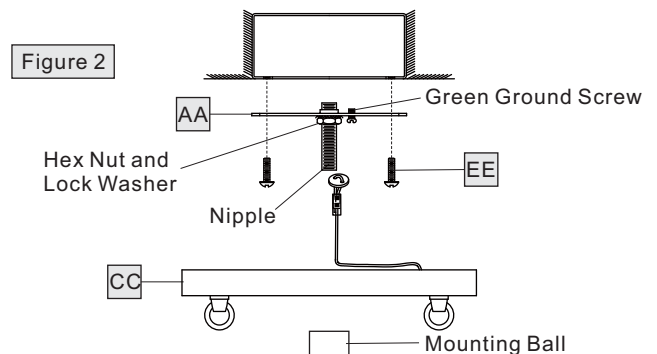

STEP 3 – Install Ceiling Canopy to Rod

- Pass supply wires and ground wire through one Quick Link (BB) and Ceiling Canopy (CC). Attach single chains underside of the Ceiling Canopy (CC) to Fixture Loops (A) by using Quick Links (BB).

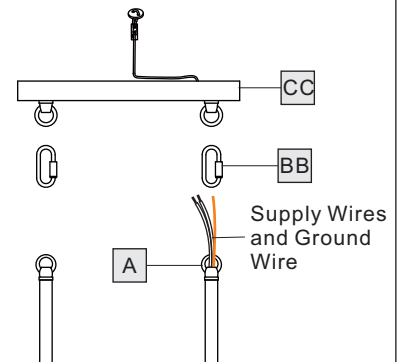

STEP 4 - Attach the Lanyard

- A. The purpose of the lanyard is to provide a means to support the fixture hands free from the junction box while connecting the electrical wires.
- B. Turn the Button Stop so it may be inserted into a Crossbar slot. Make sure the Button Stop is completely inside the Crossbar. Slowly release the fixture to make sure it is supported by the Button Stop. Proceed to the wiring steps in the next step. Once you are complete with the wiring, the Lanyard will push into the junction box when the fixture is placed for final mounting.

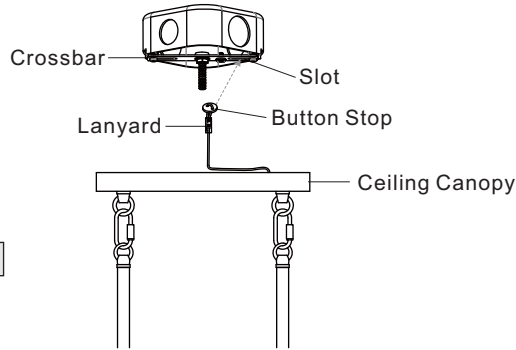

Figure 4

STEP 5 - Making the Wire Connections

- A. Wrap bare or green ground wire around green ground screw on the crossbar, no less than 2 inches from the end of the wire. Tighten the green ground screw.
- B. Use standard wire connectors (DD) to make all wire connections. Twist connectors until wires are tightly joined together. Wrap each connection with approved electrical tape and carefully stuff all the connected wires into outlet box.

Note: If the electrical wire is going to be cut shorter than provided you will need to identify the "L" line wire and the "N" neutral wire before you cut the excess wire off. One is labeled N and the other labeled L. To do this separate the "L" line wire and the "N" neutral wire as far as you need to. Re-label the wire near where you want to make the cut. Be sure to mark the wire on the side of the fixture and not on the excess wire being cut and removed.

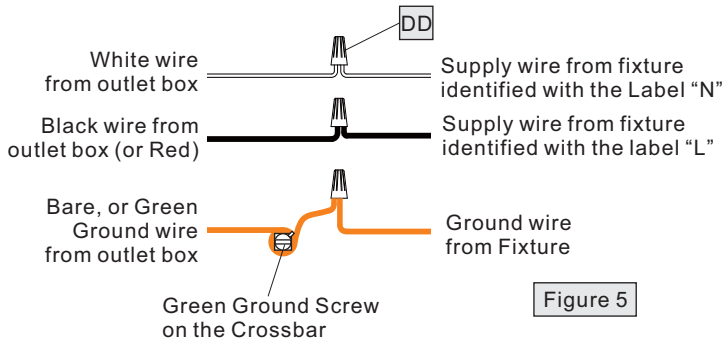

Figure 5

STEP 6 - Install Ceiling Canopy to Crossbar

- A. Attach the Ceiling Canopy (CC) over the end of the nipple and secure with previously removed mounting ball. Hand tighten until snug.

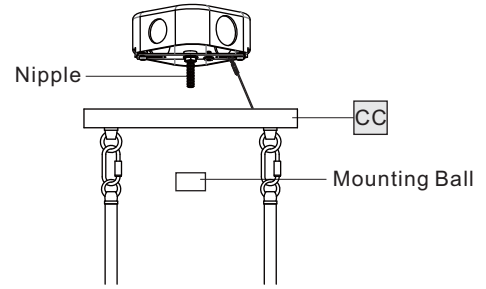

Figure 6

STEP 7 - Install Bulbs

- A. This fixture uses medium base Type-A bulbs (not supplied) with standard screw base. Maximum 100 watts. Insert bulb and screw snugly into place.

Your fixture is now assembled and ready to use. Enjoy!

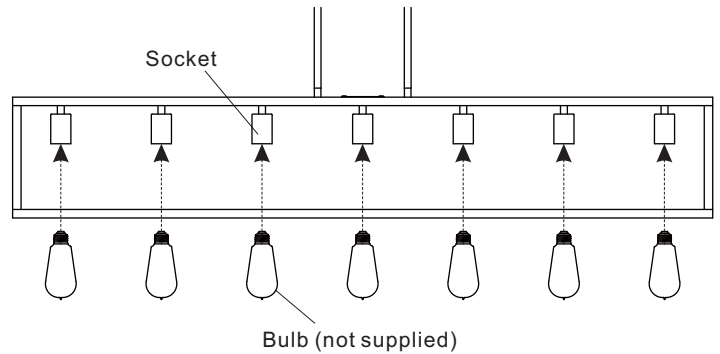

Figure 7